



XG series PLC expansion module

User Manual

WUXI XINJE ELECTRIC CO., LTD.

Data No. PG04 20220212EN 1.0

This manual includes some basic precautions which you should follow to keep you safe and protect the products. These precautions are underlined with warning triangles in the manual. About other manuals that we do not mention please follow basic electric operating rules.

Precautions



Please follow the precautions. If not, it may lead the control system incorrect or abnormal, even cause fortune lose.

Correct Application



The models could only be used according to the manual, and an only be used along with the peripheral equipment recognized or recommended by X Company. They could only work normally in the condition of be transported, kept and installed correctly, also please operate and maintain them according to the recommendation.

WUXI XINJE ELECTRIC CO., LTD. Copyright reserved
Without exact paper file allowance, copy, translate or using the manual is not allowed. Disobey this, people should take the responsibility of loss. We reserve all the right of expansions and their design patent.

Duty Declare

We have checked the manual; its content fits the hardware and software of the products. As mistakes are unavoidable, we couldn't promise all correct. However, we would check the data in the manual frequently, and in the next edition, we will correct the necessary information. Your recommendation would be highly appreciated

Catalog

1. MODULES INTRODUCTION	5
1-1. MODULE TYPE AND CONFIGURATION	5
1-1-1. <i>Module type and names</i>	5
1-1-2. <i>Module configuration</i>	5
1-2. DIMENSIONS	2
1-3. MODULE PART NAME AND FUNCTION.....	3
1-4. GENERAL SPECIFICATIONS	3
1.5 MODULE INSTALLATION	4
1-6. CONFIGURE THE MODULE	5
2. I/O EXPANSION MODULE XG-ENXMY	6
2-1. SPECIFICATIONS	6
2-2. TERMINALS	7
2-2-1. <i>Terminal explanation</i>	7
2-2-2. <i>Accessories</i>	9
2-3. I/O ADDRESS ASSIGNMENT.....	11
2-4. I/O SPECIFICATION AND WIRING.....	23
2-4-1. <i>Input specification and wiring</i>	23
2-4-2. <i>Output specification and wiring</i>	24
2-4-3. <i>Output circuit protection</i>	26
2-5. MODULE PARAMETERS	27
2-6. APPLICATIONS.....	31
3. ANALOG INPUT/OUTPUT MODULE XG-E4AD2DA.....	35
3-1. SPECIFICATION.....	35
3-2. TERMINALS	36
3-3. THE ASSIGNMENT OF I/O ADDRESS	37
3-4. WORKING MODE	43
3-5. AD CONVERSION DIAGRAM	50
3-6. PROGRAMMING.....	51
4. ANALOG INPUT MODULE XG-E8AD-A-S	53
4-1. SPECIFICATION.....	53
4-2. TERMINALS	54
4-3. I/O DISTRIBUTION	55
4-4. WORKING MODE	56
4-5. COMMUNICATION ERROR REGISTERS	62
4-6. AD CONVERSION DIAGRAM	63
4-7. PROGRAM APPLICATION	64
5. ANALOG INPUT MODULE XG-E8AD-V-S.....	65
5-1. SPECIFICATION.....	65
5-2. TERMINALS AND WIRING	66
5-3. I/O DISTRIBUTION	67

5-4. WORKING MODE	68
5-5. COMMUNICATION ERROR REGISTERS	74
5-6. AD CONVERSION DIAGRAM	75
5-7. PROGRAM APPLICATION	76
6. ANALOG OUTPUT MODULE XG-E4DA-S	77
6-1. SPECIFICATIONS	77
6-2. TERMINALS AND WIRING	78
6-3. I/O ADDRESS ASSIGNMENT	79
6-4. WORKING MODE	83
6-5. COMMUNICATION ERROR REGISTERS	86
6-6. DA CONVERSION DIAGRAM	87
6-7. PROGRAMMING	87
7. PT100 TEMPERATURE CONTROL MODULE XG-E8PT3-P	89
7-1. SPECIFICATION	89
7-2. TERMINALS AND WIRING	90
7-3. I/O ADDRESS ASSIGNMENT	92
7-4. FROM/TO INSTRUCTION	94
7-5. ADDRESS DEFINITION	97
7-6. WORKING MODE	98
7-7. COMMUNICATION ERROR REGISTER ASSIGNMENT	100
7-8. PROGRAMMING	101
8. THERMOCOUPLE TEMPERATURE CONTROL MODULE XG-E8TC-P	103
8-1. SPECIFICATION	103
8-2. TERMINALS AND WIRING	104
8-3. I/O ADDRESS ASSIGNMENT	106
8-4. WORKING MODE	112
8-5. COMMUNICATION ERROR REGISTER ASSIGNMENT	113
8-6. PROGRAMMING	114

1. Modules introduction

1-1. Module type and configuration

XG series PLCs not only have strong functions of logic operation, data operation, high speed processing etc. but also A/D, D/A conversion, PID function. With the expansions of analog input module, analog output module, temperature control module etc. XG series PLCs are widely used in the control system of temperature, flow, liquid level, pressure.

1-1-1. Module type and names

The detailed information is:

Model	Function
XG-EnXmY	N points input, M points output, PNP/NPN type input, relay/transistor output
XG-E4AD2DA	4 channels analog input (14 bits), 2 channels analog output (12 bits), the input and output are current/voltage optional
XG-E8AD-A-S	8 channels analog input module (16 bits), current mode
XG-E8AD-V-S	8 channels analog input module (16 bits), voltage mode
XG-E4DA-S	4 channels analog output module (16 bits), current/voltage optional
XG-E8PT3-P	8 channels PT100 temperature module, with PID function
XG-E8TC-P	8 channels thermocouple temperature module, with PID function

1-1-2. Module configuration

XG series expansion modules can be connected to the right side of PLC:

- Digital input, output terminal no. is octal number.
- Analog input, output terminal no. is decimal number.
- Up to 16 expansion modules can be connected to XG series PLC, the type includes digital I/O, analog I/O, temperature control modules.

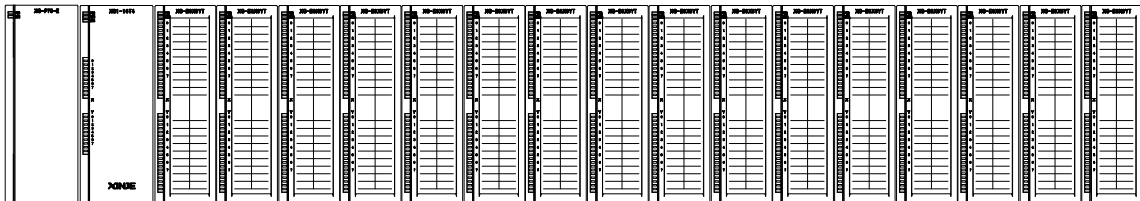

1-2. Dimensions

XG series analog, temperature, pressure modules, encoder detection, 16~32 points I/O modules: (dimension: mm)

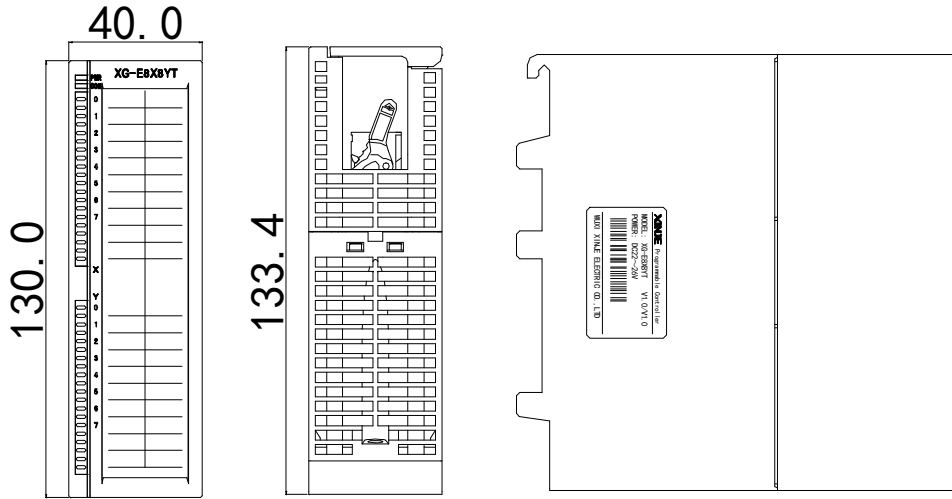

XG series 64 points I/O expansion module dimension (unit: mm)

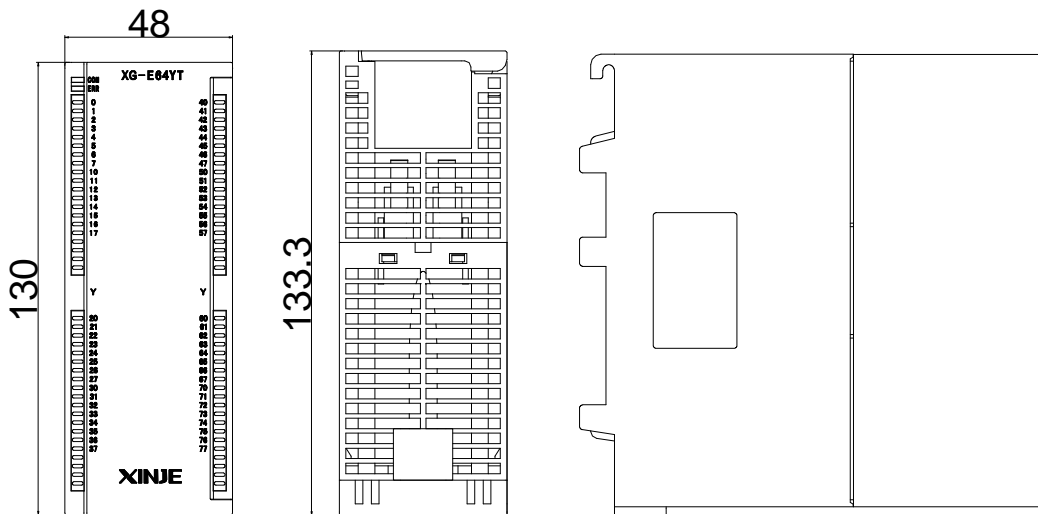

1-3. Module part name and function

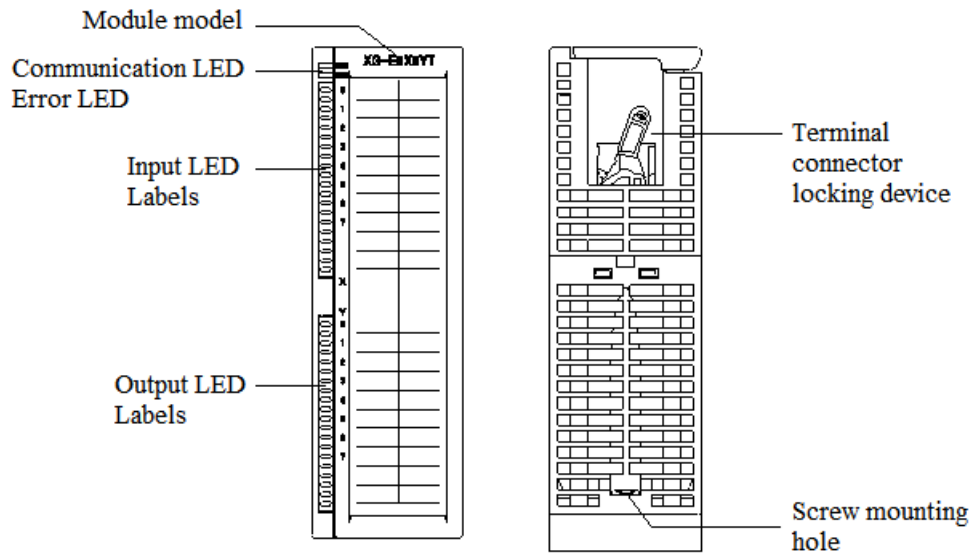

Name	Function
Module model	The model of the expansion module
Communication LED	When the module communication port communicates normally, the indicator light is on (green)
Error LED	When there is an error in the module, the indicator is always on or flashing (red) When the ERR light is always on, it indicates that the module cannot be used due to serious application errors. The use mode must be adjusted, and the PLC body is switched to the stop state When the ERR light flashes, it indicates that the module has application errors, works abnormally, and has abnormal data, but the PLC body is still run.
Input LED and labels	Whether the input point corresponding to the label is turned on
Output LED and labels	Whether the output point corresponding to the label is on or not
Terminal connector locking device	Used for fixing and removing the terminal connector and socket
Screw mounting hole	Used to fix the module on the mounting rail

1-4. General specifications

Operating Environment	No corrosive gas
Ambient Temperature	0°C~60°C
Store Temperature	-20~70°C
Ambient Humidity	5~95% RH
Store Humidity	5~95% RH
Installation	Directly installed on XG-EB series guide rail

1.5 Module installation

XG series I/O input/output, analog input/output and temperature control modules can be installed on the right side of the main unit, expansion module and special function module of XG series PLC, and XG-EB-170 and other models of guide rails can be used for their installation.

- Use Xinje XG-EB series guide rail for installation

The power module, basic unit and expansion module are installed on the XG-EB series installation guide rail. Hook the installation guide rail through the hook on the top of the back of the module, slide the module to the left to the desired position, then rotate the module down to the desired position, and finally fix the module with screws.

- Wiring method

XG series expansion modules are generally equipped with plug-in spring terminal connectors when leaving the factory. The length of wire sheath removal is required to be 1.5cm. When wiring, press the yellow spring switch with a small screwdriver, insert the wire into the corresponding jack, and release the spring switch.

- Do not install the products in the following environment

Places with direct sunlight

Ambient temperature exceeds the range of 0°C~60°C

Ambient humidity exceeds the range of 5~95% RH

Places where condensation occurs due to rapid temperature changes

Places with corrosive and combustible gases

Places with much dust, salt, iron filings and oil smoke

Places directly subject to vibration and impact

Places for spraying water, oil, drugs, etc

Places generating strong magnetic fields and electric fields

Notes:

- (1) Please confirm the specification and select the appropriate module.
- (2) When processing screw holes and wiring works, please do not let chips and wire chips fall into the module.
- (3) Before connecting, please reconfirm the specifications of the module and connecting equipment to ensure that there is no problem.
- (4) When connecting, please pay attention to whether the connection is firm. If the connection falls off, it will cause faults such as incorrect data and short circuit.
- (5) Installation, wiring and other operations must be carried out after cutting off all power supplies.

1-6. Configure the module

Before using the expansion module, please configure the module in XDPpro software.

Next we will introduce the configuration steps. Take example.

- A. Open the XDPpro software, click Configure/expansion module settings.

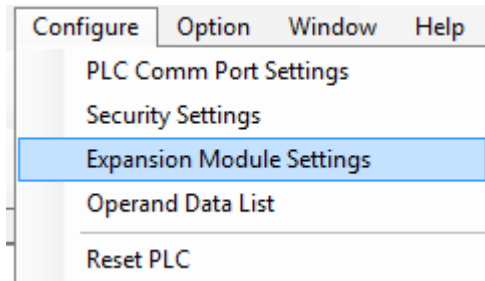

- B. Choose the module type and channel parameters in the following window. Then click write to PLC.

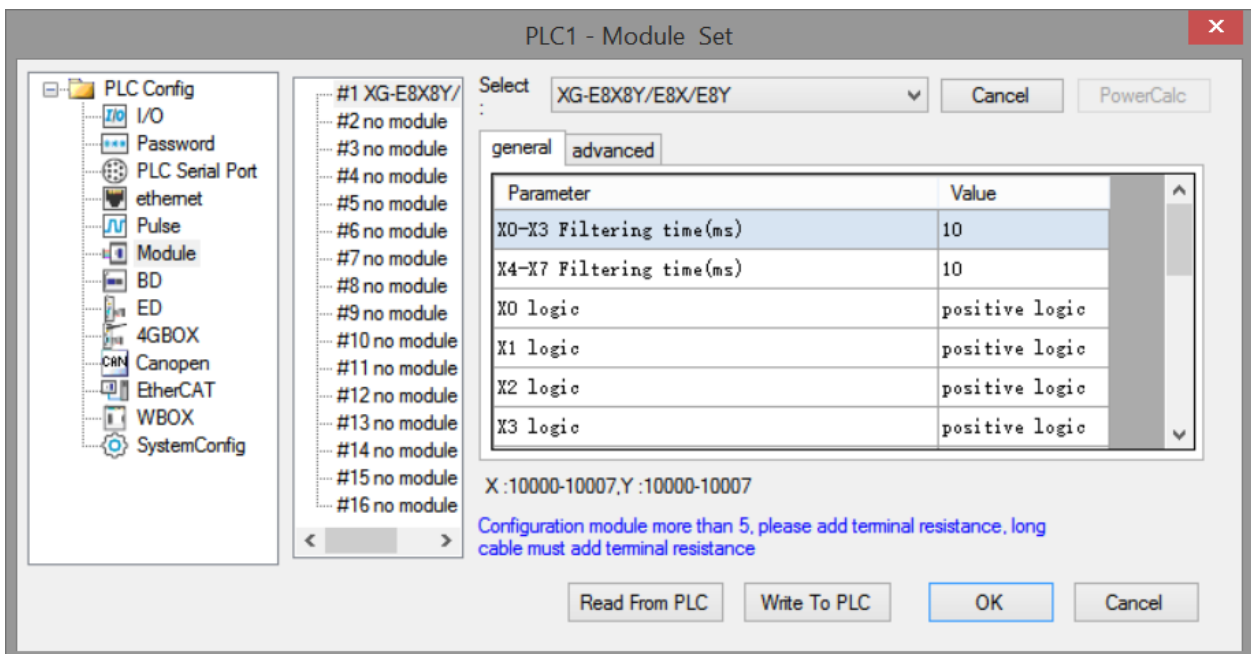

- C. Cut the PLC power supply and give the power again to make the setting effective.

Note: please use v3.5.1 or above version of Xinje PLC programming software.

2. I/O expansion module XG-EnXmY

2-1. Specifications

XG-EnXmY is the extension module of XG series, up to 16 XG-EnXmY modules can be connected to XG series PLC. This module has rich types, more I/O points which can meet more requirements.

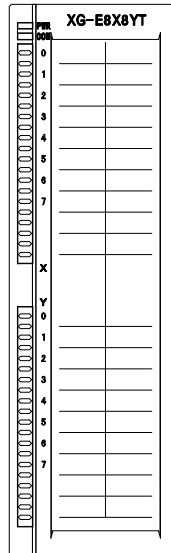

Module types

Model	Function
NPN/PNP input	
XG-E8X8YR/T	8 channels digital input, 8 channels relay/transistor output
XG-E16X	16 channels digital input
XG-E16YR/T	16 channels relay/transistor output
XG-E16X16YT	16 channels digital input, 16 channels transistor output
XG-E32YR/T	32 channels relay/transistor output
XG-E32X	32 channels digital input
XG-E64X	64 channels NPN digital input
XG-E64YT	64 channels transistor output

Module Specifications

Items	Specifications
Input voltage (Power supply)	DC24V ± 10%
Application environment	No corrosive gas
Environment temperature	0°C ~ 60°C
Environment humidity	5~95%
Installation	Directly installed on XG-EB series guide rail

Dimension	130.0mm×40.0mm×133.4mm (64 points: 130.0mm×48.0mm×133.4mm)
-----------	---

2-2. Terminals

2-2-1. Terminal explanation

The terminal and wiring mode of each model module are as follows:

XG-E8X8YT

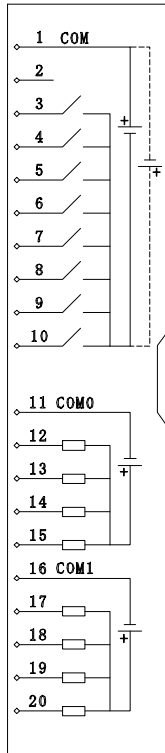

XG-E8X8YR

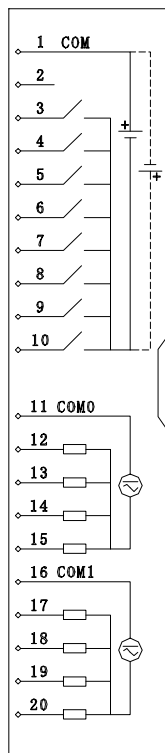

XG-E16X

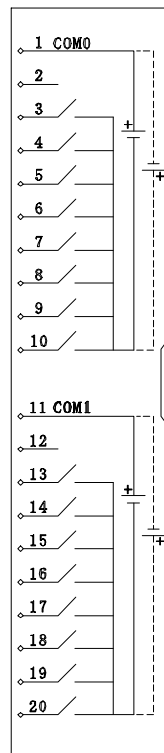

XG-E16X16YT

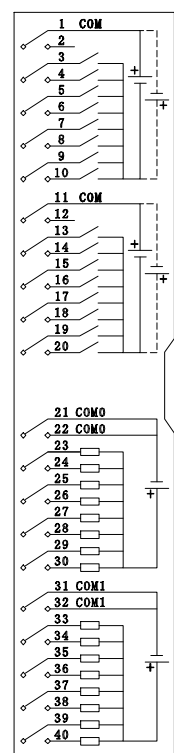

XG-E16YR

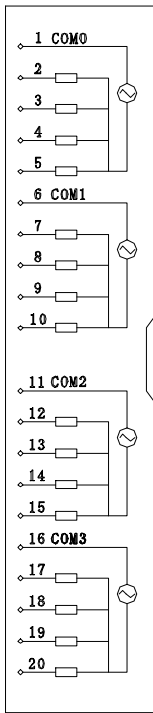

XG-E16YT

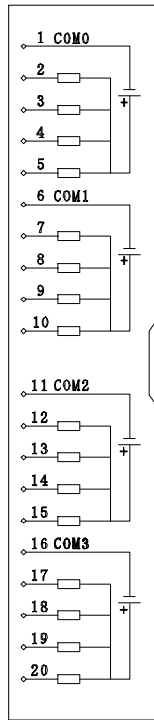

XG-E32X

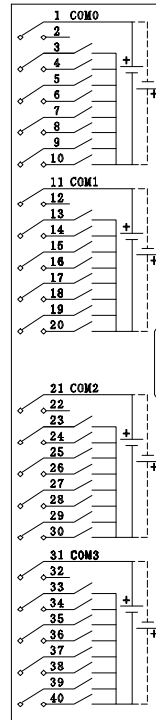

XG-E32YT

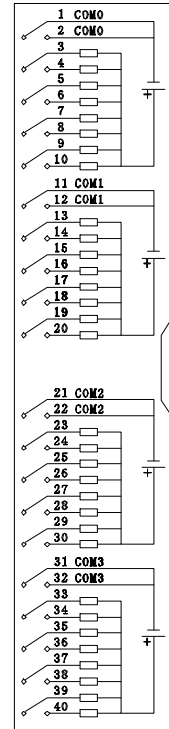

XG-E64X

① Module terminals:

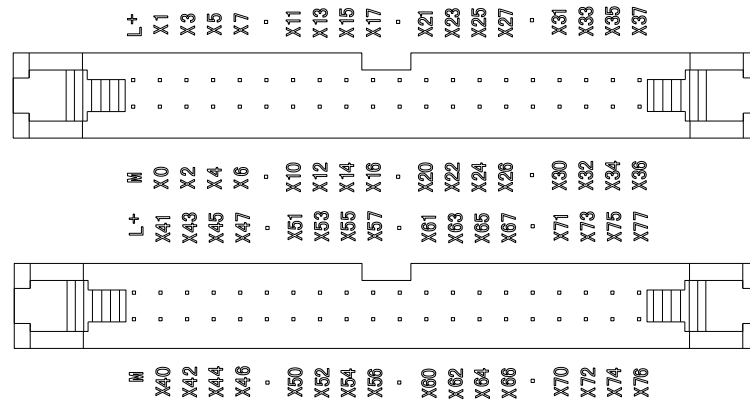

② Module external terminal block terminal:

L+	X0	X1	X2	X3	•	X10	X11	X12	X13	•	X20	X21	X22	X23	•	X30	X31	X32	X33
M	X4	X5	X6	X7	•	X14	X15	X16	X17	•	X24	X25	X26	X27	•	X34	X35	X36	X37
L+	X40	X41	X42	X43	•	X50	X51	X52	X53	•	X60	X61	X62	X63	•	X70	X71	X72	X73
M	X44	X45	X46	X47	•	X54	X55	X56	X57	•	X64	X65	X66	X67	•	X74	X75	X76	X77

XG-E64YT

① Module terminals:

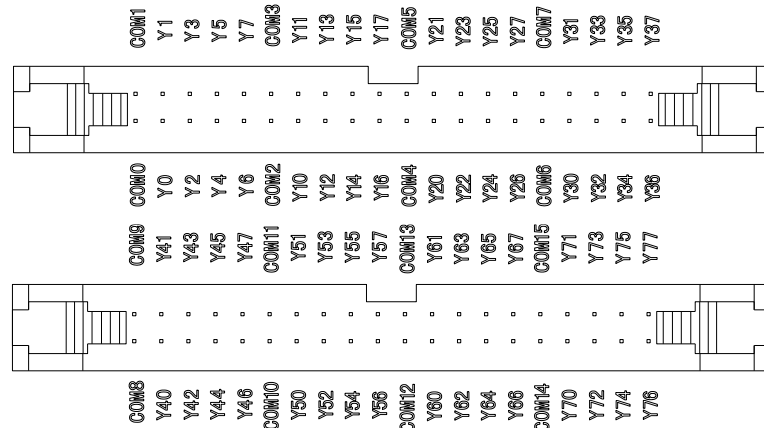

② Module external terminal block terminal:

COM0	Y0	Y1	Y2	Y3	COM2	Y10	Y11	Y12	Y13	COM4	Y20	Y21	Y22	Y23	COM6	Y30	Y31	Y32	Y33
COM1	Y4	Y5	Y6	Y7	COM3	Y14	Y15	Y16	Y17	COM5	Y24	Y25	Y26	Y27	COM7	Y34	Y35	Y36	Y37
COM0	Y40	Y41	Y42	Y43	COM2	Y50	Y51	Y52	Y53	COM4	Y60	Y61	Y62	Y63	COM6	Y70	Y71	Y72	Y73
COM1	Y44	Y45	Y46	Y47	COM3	Y54	Y55	Y56	Y57	COM5	Y64	Y65	Y66	Y67	COM7	Y74	Y75	Y76	Y77

Note:

- (1) The input terminal is compatible with NPN and PNP (XG-E64X only supports NPN wiring method). Solid line part: NPN connection method. Dotted line: PNP connection.
- (2) In the wiring diagram on the back of the cover plates of XG-E16X16YT, XG-E32X and XG-E32YT, the long pin wire near the inside of the cover plate is the left terminal on the terminal strip, and the short pin wire is the right pin on the terminal strip. The terminals are arranged left and right in turn, corresponding to the wiring diagram on the back of the cover plate.
- (3) CN0 and CN1 on XG-E64X/XG-E64YT module correspond to X0~X37/Y0~Y37 and X40~X77/Y40~Y77 respectively. External terminal blocks can be used for wiring. See "accessories" for specific usage.
- (4) The terminal strips of other digital value modules correspond to the terminals in the wiring diagram on the back of the cover plate from top to bottom.

2-2-2. Accessories

XG-E64X and XG-E64YT modules can choose external terminal blocks. Xinje provides the adaptive terminal blocks and connecting cables required by this module for users to choose.

List of module model, adaptable terminal block and connecting cable:

Module model	Terminal block	Connection cable
XG-E64X	JT-E32X	JC-TE32-NN05 (0.5m) JC-TE32-NN10 (1.0m)
XG-E64YT	JT-E32YT	JC-TE32-NN15 (1.5m)

Note: XG-E64X/ XG-E64YT need two terminal blocks of JT-E32X/ JT-E32YT.

- Terminal block dimension

(unit: mm)

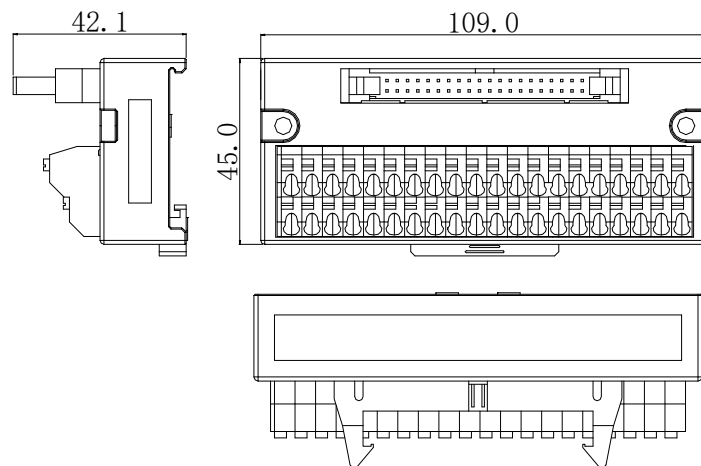

- Wiring method

When wiring, press the spring switch with a small screwdriver, insert the wire into the corresponding jack, and release the spring switch. The terminal block requires that the length of wire stripped is 1.5cm.

- Connection cable

When connecting the terminal block externally, it needs to cooperate with the use of connecting cables. Xinje provides JC-TE32-NN05, JC-TE32-NN10, JC-TE32-NN15 cables with different lengths and specifications for users to choose. Please note that when connecting, one end near the transparent heat shrinkable tube connects to the module, and the other end connect to the terminal block, which cannot be reversed!!!

The connection diagram is as follows:

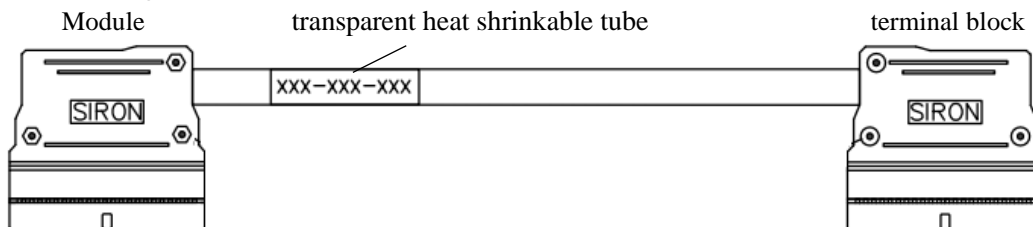

2-3. I/O address assignment

XG series can expand 16 modules. The address of I/O terminals are shown as below:

- **XG-E8X8YR, XG-E8X8YT**

Expansion module no.1 to no.16 terminal address:

	X0	X1	X2	X3	X4	X5	X6	X7
Expansion module no.1	X10000	X10001	X10002	X10003	X10004	X10005	X10006	X10007
Expansion module no.2	X10100	X10101	X10102	X10103	X10104	X10105	X10106	X10107
Expansion module no.3	X10200	X10201	X10202	X10203	X10204	X10205	X10206	X10207
Expansion module no.4	X10300	X10301	X10302	X10303	X10304	X10305	X10306	X10307
Expansion module no.5	X10400	X10401	X10402	X10403	X10404	X10405	X10406	X10407
Expansion module no.6	X10500	X10501	X10502	X10503	X10504	X10505	X10506	X10507
Expansion module no.7	X10600	X10601	X10602	X10603	X10604	X10605	X10606	X10607
Expansion module no.8	X10700	X10701	X10702	X10703	X10704	X10705	X10706	X10707
Expansion module no.9	X11000	X11001	X11002	X11003	X11004	X11005	X11006	X11007
Expansion module no.10	X11100	X11101	X11102	X11103	X11104	X11105	X11106	X11107
Expansion module no.11	X11200	X11201	X11202	X11203	X11204	X11205	X11206	X11207
Expansion module no.12	X11300	X11301	X11302	X11303	X11304	X11305	X11306	X11307
Expansion module no.13	X11400	X11401	X11402	X11403	X11404	X11405	X11406	X11407
Expansion module no.14	X11500	X11501	X11502	X11503	X11504	X11505	X11506	X11507
Expansion module no.15	X11600	X11601	X11602	X11603	X11604	X11605	X11606	X11607
Expansion module no.16	X11700	X11701	X11702	X11703	X11704	X11705	X11706	X11707

	Y0	Y1	Y2	Y3	Y4	Y5	Y6	Y7
Expansion module no.1	Y10000	Y10001	Y10002	Y10003	Y10004	Y10005	Y10006	Y10007
Expansion module no.2	Y10100	Y10101	Y10102	Y10103	Y10104	Y10105	Y10106	Y10107
Expansion module no.3	Y10200	Y10201	Y10202	Y10203	Y10204	Y10205	Y10206	Y10207
Expansion module no.4	Y10300	Y10301	Y10302	Y10303	Y10304	Y10305	Y10306	Y10307
Expansion module no.5	Y10400	Y10401	Y10402	Y10403	Y10404	Y10405	Y10406	Y10407
Expansion module no.6	Y10500	Y10501	Y10502	Y10503	Y10504	Y10505	Y10506	Y10507
Expansion module no.7	Y10600	Y10601	Y10602	Y10603	Y10604	Y10605	Y10606	Y10607
Expansion module no.8	Y10700	Y10701	Y10702	Y10703	Y10704	Y10705	Y10706	Y10707
Expansion module no.9	Y11000	Y11001	Y11002	Y11003	Y11004	Y11005	Y11006	Y11007
Expansion module no.10	Y11100	Y11101	Y11102	Y11103	Y11104	Y11105	Y11106	Y11107
Expansion module no.11	Y11200	Y11201	Y11202	Y11203	Y11204	Y11205	Y11206	Y11207
Expansion module no.12	Y11300	Y11301	Y11302	Y11303	Y11304	Y11305	Y11306	Y11307
Expansion module no.13	Y11400	Y11401	Y11402	Y11403	Y11404	Y11405	Y11406	Y11407
Expansion module no.14	Y11500	Y11501	Y11502	Y11503	Y11504	Y11505	Y11506	Y11507
Expansion module no.15	Y11600	Y11601	Y11602	Y11603	Y11604	Y11605	Y11606	Y11607

Expansion module no.16	Y11700	Y11701	Y11702	Y11703	Y11704	Y11705	Y11706	Y11707
-------------------------------	--------	--------	--------	--------	--------	--------	--------	--------

- XG-E16X**

Expansion module no.1 to no.16 input terminal address:

	Expansion module no.1	Expansion module no.2	Expansion module no.3	Expansion module no.4	Expansion module no.5	Expansion module no.6	Expansion module no.7	Expansion module no.8	Expansion module no.9	Expansion module no.10
X0	X10000	X10100	X10200	X10300	X10400	X10500	X10600	X10700	X11000	X11100
X1	X10001	X10101	X10201	X10301	X10401	X10501	X10601	X10701	X11001	X11101
X2	X10002	X10102	X10202	X10302	X10402	X10502	X10602	X10702	X11002	X11102
X3	X10003	X10103	X10203	X10303	X10403	X10503	X10603	X10703	X11003	X11103
X4	X10004	X10104	X10204	X10304	X10404	X10504	X10604	X10704	X11004	X11104
X5	X10005	X10105	X10205	X10305	X10405	X10505	X10605	X10705	X11005	X11105
X6	X10006	X10106	X10206	X10306	X10406	X10506	X10606	X10706	X11006	X11106
X7	X10007	X10107	X10207	X10307	X10407	X10507	X10607	X10707	X11007	X11107
X10	X10010	X10110	X10210	X10310	X10410	X10510	X10610	X10710	X11010	X11110
X11	X10011	X10111	X10211	X10311	X10411	X10511	X10611	X10711	X11011	X11111
X12	X10012	X10112	X10212	X10312	X10412	X10512	X10612	X10712	X11012	X11112
X13	X10013	X10113	X10213	X10313	X10413	X10513	X10613	X10713	X11013	X11113
X14	X10014	X10114	X10214	X10314	X10414	X10514	X10614	X10714	X11014	X11114
X15	X10015	X10115	X10215	X10315	X10415	X10515	X10615	X10715	X11015	X11115
X16	X10016	X10116	X10216	X10316	X10416	X10516	X10616	X10716	X11016	X11116
X17	X10017	X10117	X10217	X10317	X10417	X10517	X10617	X10717	X11017	X11117
	Expansion module no.11	Expansion module no.12	Expansion module no.13	Expansion module no.14	Expansion module no.15	Expansion module no.16				
X0	X11200	X11300	X11400	X11500	X11600	X11700				
X1	X11201	X11301	X11401	X11501	X11600	X11701				
X2	X11202	X11302	X11402	X11502	X11602	X11702				
X3	X11203	X11303	X11403	X11503	X11603	X11703				
X4	X11204	X11304	X11404	X11504	X11604	X11704				
X5	X11205	X11305	X11405	X11505	X11605	X11705				
X6	X11206	X11306	X11406	X11506	X11606	X11706				
X7	X11207	X11307	X11407	X11507	X11607	X11707				
X10	X11210	X11310	X11410	X11510	X11610	X11710				
X11	X11211	X11311	X11411	X11511	X11611	X11711				
X12	X11212	X11312	X11412	X11512	X11612	X11712				
X13	X11213	X11313	X11413	X11513	X11613	X11713				
X14	X11214	X11314	X11414	X11514	X11614	X11714				

X15	X11215	X11315	X11415	X11515	X11615	X11715				
X16	X11216	X11316	X11416	X11516	X11616	X11716				
X17	X11217	X11317	X11417	X11517	X11617	X11717				

- **XG-E16YR, XG-E16YT**

Expansion module no.1 to no.16 output terminal address:

	Expansion module no.1	Expansion module no.2	Expansion module no.3	Expansion module no.4	Expansion module no.5	Expansion module no.6	Expansion module no.7	Expansion module no.8	Expansion module no.9	Expansion module no.10
Y0	Y10000	Y10100	Y10200	Y10300	Y10400	Y10500	Y10600	Y10700	Y11000	Y11100
Y1	Y10001	Y10101	Y10201	Y10301	Y10401	Y10501	Y10601	Y10701	Y11001	Y11101
Y2	Y10002	Y10102	Y10202	Y10302	Y10402	Y10502	Y10602	Y10702	Y11002	Y11102
Y3	Y10003	Y10103	Y10203	Y10303	Y10403	Y10503	Y10603	Y10703	Y11003	Y11103
Y4	Y10004	Y10104	Y10204	Y10304	Y10404	Y10504	Y10604	Y10704	Y11004	Y11104
Y5	Y10005	Y10105	Y10205	Y10305	Y10405	Y10505	Y10605	Y10705	Y11005	Y11105
Y6	Y10006	Y10106	Y10206	Y10306	Y10406	Y10506	Y10606	Y10706	Y11006	Y11106
Y7	Y10007	Y10107	Y10207	Y10307	Y10407	Y10507	Y10607	Y10707	Y11007	Y11107
Y10	Y10010	Y10110	Y10210	Y10310	Y10410	Y10510	Y10610	Y10710	Y11010	Y11110
Y11	Y10011	Y10111	Y10211	Y10311	Y10411	Y10511	Y10611	Y10711	Y11011	Y11111
Y12	Y10012	Y10112	Y10212	Y10312	Y10412	Y10512	Y10612	Y10712	Y11012	Y11112
Y13	Y10013	Y10113	Y10213	Y10313	Y10413	Y10513	Y10613	Y10713	Y11013	Y11113
Y14	Y10014	Y10114	Y10214	Y10314	Y10414	Y10514	Y10614	Y10714	Y11014	Y11114
Y15	Y10015	Y10115	Y10215	Y10315	Y10415	Y10515	Y10615	Y10715	Y11015	Y11115
Y16	Y10016	Y10116	Y10216	Y10316	Y10416	Y10516	Y10616	Y10716	Y11016	Y11116
Y17	Y10017	Y10117	Y10217	Y10317	Y10417	Y10517	Y10617	Y10717	Y11017	Y11117
	Expansion module no.11	Expansion module no.12	Expansion module no.13	Expansion module no.14	Expansion module no.15	Expansion module no.16				
Y0	Y11200	Y11300	Y11400	Y11500	Y11600	Y11700				
Y1	Y11201	Y11301	Y11401	Y11501	Y11600	Y11701				
Y2	Y11202	Y11302	Y11402	Y11502	Y11602	Y11702				
Y3	Y11203	Y11303	Y11403	Y11503	Y11603	Y11703				
Y4	Y11204	Y11304	Y11404	Y11504	Y11604	Y11704				
Y5	Y11205	Y11305	Y11405	Y11505	Y11605	Y11705				
Y6	Y11206	Y11306	Y11406	Y11506	Y11606	Y11706				
Y7	Y11207	Y11307	Y11407	Y11507	Y11607	Y11707				
Y10	Y11210	Y11310	Y11410	Y11510	Y11610	Y11710				
Y11	Y11211	Y11311	Y11411	Y11511	Y11611	Y11711				
Y12	Y11212	Y11312	Y11412	Y11512	Y11612	Y11712				

Y13	Y11213	Y11313	Y11413	Y11513	Y11613	Y11713				
Y14	Y11214	Y11314	Y11414	Y11514	Y11614	Y11714				
Y15	Y11215	Y11315	Y11415	Y11515	Y11615	Y11715				
Y16	Y11216	Y11316	Y11416	Y11516	Y11616	Y11716				
Y17	Y11217	Y11317	Y11417	Y11517	Y11617	Y11717				

- **XG-E16X16YR, XG-E16X16YT**

Expansion module no.1 to no.16 input terminal address:

	Expansion module no.1	Expansion module no.2	Expansion module no.3	Expansion module no.4	Expansion module no.5	Expansion module no.6	Expansion module no.7	Expansion module no.8	Expansion module no.9	Expansion module no.10
X0	X10000	X10100	X10200	X10300	X10400	X10500	X10600	X10700	X11000	X11100
X1	X10001	X10101	X10201	X10301	X10401	X10501	X10601	X10701	X11001	X11101
X2	X10002	X10102	X10202	X10302	X10402	X10502	X10602	X10702	X11002	X11102
X3	X10003	X10103	X10203	X10303	X10403	X10503	X10603	X10703	X11003	X11103
X4	X10004	X10104	X10204	X10304	X10404	X10504	X10604	X10704	X11004	X11104
X5	X10005	X10105	X10205	X10305	X10405	X10505	X10605	X10705	X11005	X11105
X6	X10006	X10106	X10206	X10306	X10406	X10506	X10606	X10706	X11006	X11106
X7	X10007	X10107	X10207	X10307	X10407	X10507	X10607	X10707	X11007	X11107
X10	X10010	X10110	X10210	X10310	X10410	X10510	X10610	X10710	X11010	X11110
X11	X10011	X10111	X10211	X10311	X10411	X10511	X10611	X10711	X11011	X11111
X12	X10012	X10112	X10212	X10312	X10412	X10512	X10612	X10712	X11012	X11112
X13	X10013	X10113	X10213	X10313	X10413	X10513	X10613	X10713	X11013	X11113
X14	X10014	X10114	X10214	X10314	X10414	X10514	X10614	X10714	X11014	X11114
X15	X10015	X10115	X10215	X10315	X10415	X10515	X10615	X10715	X11015	X11115
X16	X10016	X10116	X10216	X10316	X10416	X10516	X10616	X10716	X11016	X11116
X17	X10017	X10117	X10217	X10317	X10417	X10517	X10617	X10717	X11017	X11117
	Expansion module no.11	Expansion module no.12	Expansion module no.13	Expansion module no.14	Expansion module no.15	Expansion module no.16				
X0	X11200	X11300	X11400	X11500	X11600	X11700				
X1	X11201	X11301	X11401	X11501	X11600	X11701				
X2	X11202	X11302	X11402	X11502	X11602	X11702				
X3	X11203	X11303	X11403	X11503	X11603	X11703				
X4	X11204	X11304	X11404	X11504	X11604	X11704				
X5	X11205	X11305	X11405	X11505	X11605	X11705				
X6	X11206	X11306	X11406	X11506	X11606	X11706				
X7	X11207	X11307	X11407	X11507	X11607	X11707				
X10	X11210	X11310	X11410	X11510	X11610	X11710				
X11	X11211	X11311	X11411	X11511	X11611	X11711				

X12	X11212	X11312	X11412	X11512	X11612	X11712				
X13	X11213	X11313	X11413	X11513	X11613	X11713				
X14	X11214	X11314	X11414	X11514	X11614	X11714				
X15	X11215	X11315	X11415	X11515	X11615	X11715				
X16	X11216	X11316	X11416	X11516	X11616	X11716				
X17	X11217	X11317	X11417	X11517	X11617	X11717				

	Expansion module no.1	Expansion module no.2	Expansion module no.3	Expansion module no.4	Expansion module no.5	Expansion module no.6	Expansion module no.7	Expansion module no.8	Expansion module no.9	Expansion module no.10
Y0	Y10000	Y10100	Y10200	Y10300	Y10400	Y10500	Y10600	Y10700	Y11000	Y11100
Y1	Y10001	Y10101	Y10201	Y10301	Y10401	Y10501	Y10601	Y10701	Y11001	Y11101
Y2	Y10002	Y10102	Y10202	Y10302	Y10402	Y10502	Y10602	Y10702	Y11002	Y11102
Y3	Y10003	Y10103	Y10203	Y10303	Y10403	Y10503	Y10603	Y10703	Y11003	Y11103
Y4	Y10004	Y10104	Y10204	Y10304	Y10404	Y10504	Y10604	Y10704	Y11004	Y11104
Y5	Y10005	Y10105	Y10205	Y10305	Y10405	Y10505	Y10605	Y10705	Y11005	Y11105
Y6	Y10006	Y10106	Y10206	Y10306	Y10406	Y10506	Y10606	Y10706	Y11006	Y11106
Y7	Y10007	Y10107	Y10207	Y10307	Y10407	Y10507	Y10607	Y10707	Y11007	Y11107
Y10	Y10010	Y10110	Y10210	Y10310	Y10410	Y10510	Y10610	Y10710	Y11010	Y11110
Y11	Y10011	Y10111	Y10211	Y10311	Y10411	Y10511	Y10611	Y10711	Y11011	Y11111
Y12	Y10012	Y10112	Y10212	Y10312	Y10412	Y10512	Y10612	Y10712	Y11012	Y11112
Y13	Y10013	Y10113	Y10213	Y10313	Y10413	Y10513	Y10613	Y10713	Y11013	Y11113
Y14	Y10014	Y10114	Y10214	Y10314	Y10414	Y10514	Y10614	Y10714	Y11014	Y11114
Y15	Y10015	Y10115	Y10215	Y10315	Y10415	Y10515	Y10615	Y10715	Y11015	Y11115
Y16	Y10016	Y10116	Y10216	Y10316	Y10416	Y10516	Y10616	Y10716	Y11016	Y11116
Y17	Y10017	Y10117	Y10217	Y10317	Y10417	Y10517	Y10617	Y10717	Y11017	X11117
	Expansion module no.11	Expansion module no.12	Expansion module no.13	Expansion module no.14	Expansion module no.15	Expansion module no.16				
Y0	Y11200	Y11300	Y11400	Y11500	Y11600	Y11700				
Y1	Y11201	Y11301	Y11401	Y11501	Y11600	Y11701				
Y2	Y11202	Y11302	Y11402	Y11502	Y11602	Y11702				
Y3	Y11203	Y11303	Y11403	Y11503	Y11603	Y11703				
Y4	Y11204	Y11304	Y11404	Y11504	Y11604	Y11704				
Y5	Y11205	Y11305	Y11405	Y11505	Y11605	Y11705				
Y6	Y11206	Y11306	Y11406	Y11506	Y11606	Y11706				
Y7	Y11207	Y11307	Y11407	Y11507	Y11607	Y11707				
Y10	Y11210	Y11310	Y11410	Y11510	Y11610	Y11710				
Y11	Y11211	Y11311	Y11411	Y11511	Y11611	Y11711				
Y12	Y11212	Y11312	Y11412	Y11512	Y11612	Y11712				
Y13	Y11213	Y11313	Y11413	Y11513	Y11613	Y11713				

Y14	Y11214	Y11314	Y11414	Y11514	Y11614	Y11714				
Y15	Y11215	Y11315	Y11415	Y11515	Y11615	Y11715				
Y16	Y11216	Y11316	Y11416	Y11516	Y11616	Y11716				
Y17	Y11217	Y11317	Y11417	Y11517	Y11617	Y11717				

- **XG-E32YT**

Expansion module no.1 to no.16 input terminal address:

	Expansion module no.1	Expansion module no.2	Expansion module no.3	Expansion module no.4	Expansion module no.5	Expansion module no.6	Expansion module no.7	Expansion module no.8	Expansion module no.9	Expansion module no.10
Y0	Y10000	Y10100	Y10200	Y10300	Y10400	Y10500	Y10600	Y10700	Y11000	Y11100
Y1	Y10001	Y10101	Y10201	Y10301	Y10401	Y10501	Y10601	Y10701	Y11001	Y11101
Y2	Y10002	Y10102	Y10202	Y10302	Y10402	Y10502	Y10602	Y10702	Y11002	Y11102
Y3	Y10003	Y10103	Y10203	Y10303	Y10403	Y10503	Y10603	Y10703	Y11003	Y11103
Y4	Y10004	Y10104	Y10204	Y10304	Y10404	Y10504	Y10604	Y10704	Y11004	Y11104
Y5	Y10005	Y10105	Y10205	Y10305	Y10405	Y10505	Y10605	Y10705	Y11005	Y11105
Y6	Y10006	Y10106	Y10206	Y10306	Y10406	Y10506	Y10606	Y10706	Y11006	Y11106
Y7	Y10007	Y10107	Y10207	Y10307	Y10407	Y10507	Y10607	Y10707	Y11007	Y11107
Y10	Y10010	Y10110	Y10210	Y10310	Y10410	Y10510	Y10610	Y10710	Y11010	Y11110
Y11	Y10011	Y10111	Y10211	Y10311	Y10411	Y10511	Y10611	Y10711	Y11011	Y11111
Y12	Y10012	Y10112	Y10212	Y10312	Y10412	Y10512	Y10612	Y10712	Y11012	Y11112
Y13	Y10013	Y10113	Y10213	Y10313	Y10413	Y10513	Y10613	Y10713	Y11013	Y11113
Y14	Y10014	Y10114	Y10214	Y10314	Y10414	Y10514	Y10614	Y10714	Y11014	Y11114
Y15	Y10015	Y10115	Y10215	Y10315	Y10415	Y10515	Y10615	Y10715	Y11015	Y11115
Y16	Y10016	Y10116	Y10216	Y10316	Y10416	Y10516	Y10616	Y10716	Y11016	Y11116
Y17	Y10017	Y10117	Y10217	Y10317	Y10417	Y10517	Y10617	Y10717	Y11017	X11117
Y20	Y10020	Y10120	Y10220	Y10320	Y10420	Y10520	Y10620	Y10720	Y11020	Y11120
Y21	Y10021	Y10121	Y10221	Y10321	Y10421	Y10521	Y10621	Y10721	Y11021	Y11121
Y22	Y10022	Y10122	Y10222	Y10322	Y10422	Y10522	Y10622	Y10722	Y11022	Y11122
Y23	Y10023	Y10123	Y10223	Y10323	Y10423	Y10523	Y10623	Y10723	Y11023	Y11123
Y24	Y10024	Y10124	Y10224	Y10324	Y10424	Y10524	Y10624	Y10724	Y11024	Y11124
Y25	Y10025	Y10125	Y10225	Y10325	Y10425	Y10525	Y10625	Y10725	Y11025	Y11125
Y26	Y10026	Y10126	Y10226	Y10326	Y10426	Y10526	Y10626	Y10726	Y11026	Y11126
Y27	Y10027	Y10127	Y10227	Y10327	Y10427	Y10527	Y10627	Y10727	Y11027	Y11127
Y30	Y10030	Y10130	Y10230	Y10330	Y10430	Y10530	Y10630	Y10730	Y11030	Y11130
Y31	Y10031	Y10131	Y10231	Y10331	Y10431	Y10531	Y10631	Y10731	Y11031	Y11131
Y32	Y10032	Y10132	Y10232	Y10332	Y10432	Y10532	Y10632	Y10732	Y11032	Y11132
Y33	Y10033	Y10133	Y10233	Y10333	Y10433	Y10533	Y10633	Y10733	Y11033	Y11133
Y34	Y10034	Y10134	Y10234	Y10334	Y10434	Y10534	Y10634	Y10734	Y11034	Y11134

Y35	Y10035	Y10135	Y10235	Y10335	Y10435	Y10535	Y10635	Y10735	Y11035	Y11135
Y36	Y10036	Y10136	Y10236	Y10336	Y10436	Y10536	Y10636	Y10736	Y11036	Y11136
Y37	Y10037	Y10137	Y10237	Y10337	Y10437	Y10537	Y10637	Y10737	Y11037	Y11137
	Expansion module no.11	Expansion module no.12	Expansion module no.13	Expansion module no.14	Expansion module no.15	Expansion module no.16				
Y0	Y11200	Y11300	Y11400	Y11500	Y11600	Y11700				
Y1	Y11201	Y11301	Y11401	Y11501	Y11601	Y11701				
Y2	Y11202	Y11302	Y11402	Y11502	Y11602	Y11702				
Y3	Y11203	Y11303	Y11403	Y11503	Y11603	Y11703				
Y4	Y11204	Y11304	Y11404	Y11504	Y11604	Y11704				
Y5	Y11205	Y11305	Y11405	Y11505	Y11605	Y11705				
Y6	Y11206	Y11306	Y11406	Y11506	Y11606	Y11706				
Y7	Y11207	Y11307	Y11407	Y11507	Y11607	Y11707				
Y10	Y11210	Y11310	Y11410	Y11510	Y11610	Y11710				
Y11	Y11211	Y11311	Y11411	Y11511	Y11611	Y11711				
Y12	Y11212	Y11312	Y11412	Y11512	Y11612	Y11712				
Y13	Y11213	Y11313	Y11413	Y11513	Y11613	Y11713				
Y14	Y11214	Y11314	Y11414	Y11514	Y11614	Y11714				
Y15	Y11215	Y11315	Y11415	Y11515	Y11615	Y11715				
Y16	Y11216	Y11316	Y11416	Y11516	Y11616	Y11716				
Y17	X11217	X11317	X11417	X11517	X11617	X11717				
Y20	Y11220	Y11320	Y11420	Y11520	Y11620	Y11720				
Y21	Y11221	Y11321	Y11421	Y11521	Y11621	Y11721				
Y22	Y11222	Y11322	Y11422	Y11522	Y11622	Y11722				
Y23	Y11223	Y11323	Y11423	Y11523	Y11623	Y11723				
Y24	Y11224	Y11324	Y11424	Y11524	Y11624	Y11724				
Y25	Y11225	Y11325	Y11425	Y11525	Y11625	Y11725				
Y26	Y11226	Y11326	Y11426	Y11526	Y11626	Y11726				
Y27	Y11227	Y11327	Y11427	Y11527	Y11627	Y11727				
Y30	Y11230	Y11330	Y11430	Y11530	Y11630	Y11730				
Y31	Y11231	Y11331	Y11431	Y11531	Y11631	Y11731				
Y32	Y11232	Y11332	Y11432	Y11532	Y11632	Y11732				
Y33	Y11233	Y11333	Y11433	Y11533	Y11633	Y11733				
Y34	Y11234	Y11334	Y11434	Y11534	Y11634	Y11734				
Y35	Y11235	Y11335	Y11435	Y11535	Y11635	Y11735				
Y36	Y11236	Y11336	Y11436	Y11536	Y11636	Y11736				
Y37	Y11237	Y11337	Y11437	Y11537	Y11637	Y11737				

- **XG-E32X**

Expansion module no.1 to no.16 input terminal address:

	Expansion module no.1	Expansion module no.2	Expansion module no.3	Expansion module no.4	Expansion module no.5	Expansion module no.6	Expansion module no.7	Expansion module no.8	Expansion module no.9	Expansion module no.10
X0	X10000	X10100	X10200	X10300	X10400	X10500	X10600	X10700	X11000	X11100
X1	X10001	X10101	X10201	X10301	X10401	X10501	X10601	X10701	X11001	X11101
X2	X10002	X10102	X10202	X10302	X10402	X10502	X10602	X10702	X11002	X11102
X3	X10003	X10103	X10203	X10303	X10403	X10503	X10603	X10703	X11003	X11103
X4	X10004	X10104	X10204	X10304	X10404	X10504	X10604	X10704	X11004	X11104
X5	X10005	X10105	X10205	X10305	X10405	X10505	X10605	X10705	X11005	X11105
X6	X10006	X10106	X10206	X10306	X10406	X10506	X10606	X10706	X11006	X11106
X7	X10007	X10107	X10207	X10307	X10407	X10507	X10607	X10707	X11007	X11107
X10	X10010	X10110	X10210	X10310	X10410	X10510	X10610	X10710	X11010	X11110
X11	X10011	X10111	X10211	X10311	X10411	X10511	X10611	X10711	X11011	X11111
X12	X10012	X10112	X10212	X10312	X10412	X10512	X10612	X10712	X11012	X11112
X13	X10013	X10113	X10213	X10313	X10413	X10513	X10613	X10713	X11013	X11113
X14	X10014	X10114	X10214	X10314	X10414	X10514	X10614	X10714	X11014	X11114
X15	X10015	X10115	X10215	X10315	X10415	X10515	X10615	X10715	X11015	X11115
X16	X10016	X10116	X10216	X10316	X10416	X10516	X10616	X10716	X11016	X11116
X17	X10017	X10117	X10217	X10317	X10417	X10517	X10617	X10717	X11017	X11117
X20	X10020	X10120	X10220	X10320	X10420	X10520	X10620	X10720	X11020	X11120
X21	X10021	X10121	X10221	X10321	X10421	X10521	X10621	X10721	X11021	X11121
X22	X10022	X10122	X10222	X10322	X10422	X10522	X10622	X10722	X11022	X11122
X23	X10023	X10123	X10223	X10323	X10423	X10523	X10623	X10723	X11023	X11123
X24	X10024	X10124	X10224	X10324	X10424	X10524	X10624	X10724	X11024	X11124
X25	X10025	X10125	X10225	X10325	X10425	X10525	X10625	X10725	X11025	X11125
X26	X10026	X10126	X10226	X10326	X10426	X10526	X10626	X10726	X11026	X11126
X27	X10027	X10127	X10227	X10327	X10427	X10527	X10627	X10727	X11027	X11127
X30	X10030	X10130	X10230	X10330	X10430	X10530	X10630	X10730	X11030	X11130
X31	X10031	X10131	X10231	X10331	X10431	X10531	X10631	X10731	X11031	X11131
X32	X10032	X10132	X10232	X10332	X10432	X10532	X10632	X10732	X11032	X11132
X33	X10033	X10133	X10233	X10333	X10433	X10533	X10633	X10733	X11033	X11133
X34	X10034	X10134	X10234	X10334	X10434	X10534	X10634	X10734	X11034	X11134
X35	X10035	X10135	X10235	X10335	X10435	X10535	X10635	X10735	X11035	X11135
X36	X10036	X10136	X10236	X10336	X10436	X10536	X10636	X10736	X11036	X11136
X37	X10037	X10137	X10237	X10337	X10437	X10537	X10637	X10737	X11037	X11137
	Expansion module no.11	Expansion module no.12	Expansion module no.13	Expansion module no.14	Expansion module no.15	Expansion module no.16				
X0	X11200	X11300	X11400	X11500	X11600	X11700				

X1	X11201	X11301	X11401	X11501	X11601	X11701				
X2	X11202	X11302	X11402	X11502	X11602	X11702				
X3	X11203	X11303	X11403	X11503	X11603	X11703				
X4	X11204	X11304	X11404	X11504	X11604	X11704				
X5	X11205	X11305	X11405	X11505	X11605	X11705				
X6	X11206	X11306	X11406	X11506	X11606	X11706				
X7	X11207	X11307	X11407	X11507	X11607	X11707				
X10	X11210	X11310	X11410	X11510	X11610	X11710				
X11	X11211	X11311	X11411	X11511	X11611	X11711				
X12	X11212	X11312	X11412	X11512	X11612	X11712				
X13	X11213	X11313	X11413	X11513	X11613	X11713				
X14	X11214	X11314	X11414	X11514	X11614	X11714				
X15	X11215	X11315	X11415	X11515	X11615	X11715				
X16	X11216	X11316	X11416	X11516	X11616	X11716				
X17	X11217	X11317	X11417	X11517	X11617	X11717				
X20	X11220	X11320	X11420	X11520	X11620	X11720				
X21	X11221	X11321	X11421	X11521	X11621	X11721				
X22	X11222	X11322	X11422	X11522	X11622	X11722				
X23	X11223	X11323	X11423	X11523	X11623	X11723				
X24	X11224	X11324	X11424	X11524	X11624	X11724				
X25	X11225	X11325	X11425	X11525	X11625	X11725				
X26	X11226	X11326	X11426	X11526	X11626	X11726				
X27	X11227	X11327	X11427	X11527	X11627	X11727				
X30	X11230	X11330	X11430	X11530	X11630	X11730				
X31	X11231	X11331	X11431	X11531	X11631	X11731				
X32	X11232	X11332	X11432	X11532	X11632	X11732				
X33	X11233	X11333	X11433	X11533	X11633	X11733				
X34	X11234	X11334	X11434	X11534	X11634	X11734				
X35	X11235	X11335	X11435	X11535	X11635	X11735				
X36	X11236	X11336	X11436	X11536	X11636	X11736				
X37	X11237	X11337	X11437	X11537	X11637	X11737				

- **XG-E64X**

	Expansion module no.1	Expansion module no.2	Expansion module no.3	Expansion module no.4	Expansion module no.5	Expansion module no.6	Expansion module no.7	Expansion module no.8
X0	X10000	X10100	X10200	X10300	X10400	X10500	X10600	X10700
X1	X10001	X10101	X10201	X10301	X10401	X10501	X10601	X10701
...
X7	X10007	X10107	X10207	X10307	X10407	X10507	X10607	X10707
X10	X10010	X10110	X10210	X10310	X10410	X10510	X10610	X10710

X57	X11057	X11157	X11257	X11357	X11457	X11557	X11657	X11757
X60	X11060	X11160	X11260	X11360	X11460	X11560	X11660	X11760
...
X67	X11067	X11167	X11267	X11367	X11467	X11567	X11667	X11767
X70	X11070	X11170	X11270	X11370	X11470	X11570	X11670	X11770
...
X77	X11077	X11177	X11277	X11377	X11477	X11577	X11677	X11777

• XG-E64YT

	Expansion module no.1	Expansion module no.2	Expansion module no.3	Expansion module no.4	Expansion module no.5	Expansion module no.6	Expansion module no.7	Expansion module no.8
Y0	Y10000	Y10100	Y10200	Y10300	Y10400	Y10500	Y10600	Y10700
Y1	Y10001	Y10101	Y10201	Y10301	Y10401	Y10501	Y10601	Y10701
...
Y7	Y10007	Y10107	Y10207	Y10307	Y10407	Y10507	Y10607	Y10707
Y10	Y10010	Y10110	Y10210	Y10310	Y10410	Y10510	Y10610	Y10710
...
Y17	Y10017	Y10117	Y10217	Y10317	Y10417	Y10517	Y10617	Y10717
Y20	Y10020	Y10120	Y10220	Y10320	Y10420	Y10520	Y10620	Y10720
...
Y27	Y10027	Y10127	Y10227	Y10327	Y10427	Y10527	Y10627	Y10727
Y30	Y10030	Y10130	Y10230	Y10330	Y10430	Y10530	Y10630	Y10730
...
Y36	Y10036	Y10136	Y10236	Y10336	Y10436	Y10536	Y10636	Y10736
Y37	Y10037	Y10137	Y10237	Y10337	Y10437	Y10537	Y10637	Y10737
Y40	Y10040	Y10140	Y10240	Y10340	Y10440	Y10540	Y10640	Y10740
Y41	Y10041	Y10141	Y10241	Y10341	Y10401	Y10541	Y10641	Y10741
...
Y47	Y10047	Y10147	Y10247	Y10347	Y10447	Y10547	Y10647	Y10747
Y50	Y10050	Y10150	Y10250	Y10350	Y10450	Y10550	Y10650	Y10750
...
Y57	Y10057	Y10157	Y10257	Y10357	Y10457	Y10557	Y10657	Y10757
Y60	Y10060	Y10160	Y10260	Y10360	Y10460	Y10560	Y10660	Y10760
...
Y67	Y10067	Y10167	Y10267	Y10367	Y10467	Y10567	Y10667	Y10767
Y70	Y10070	Y10170	Y10270	Y10370	Y10470	Y10570	Y10670	Y10770
...
Y76	Y10076	Y10176	Y10276	Y10376	Y10476	Y10576	Y10676	Y10776
Y77	Y10077	Y10177	Y10277	Y10377	Y10477	Y10577	Y10677	Y10777

	Expansion module no.9	Expansion module no.10	Expansion module no.11	Expansion module no.12	Expansion module no.13	Expansion module no.14	Expansion module no.15	Expansion module no.16
Y0	Y11000	Y11100	Y11200	Y11300	Y11400	Y11500	Y11600	Y11700
Y1	Y11001	Y11101	Y11201	Y11301	Y11401	Y11501	Y11601	Y11701
...
Y7	Y11007	Y11107	Y11207	Y11307	Y11407	Y11507	Y11607	Y11707
Y10	Y11010	Y11110	Y11210	Y11310	Y11410	Y11510	Y11610	Y11710
...
Y17	Y11017	X11117	X11217	X11317	X11417	X11517	X11617	X11717
Y20	Y11020	Y11120	Y11220	Y11320	Y11420	Y11520	Y11620	Y11720
...
Y27	Y11027	Y11127	Y11227	Y11327	Y11427	Y11527	Y11627	Y11727
Y30	Y11030	Y11130	Y11230	Y11330	Y11430	Y11530	Y11630	Y11730
...
Y36	Y11036	Y11136	Y11236	Y11336	Y11436	Y11536	Y11636	Y11736
Y37	Y11037	Y11137	Y11237	Y11337	Y11437	Y11537	Y11637	Y11737
Y40	Y11040	Y11140	Y11240	Y11340	Y11440	Y11540	Y11640	Y11740
Y41	Y11041	Y11141	Y11241	Y11341	Y11441	Y11541	Y11641	Y11741
...
Y47	Y11047	Y11147	Y11247	Y11347	Y11447	Y11547	Y11647	Y11747
Y50	Y11050	Y11150	Y11250	Y11350	Y11450	Y11550	Y11650	Y11750
...
Y57	Y11057	X11157	X11257	X11357	X11457	X11557	X11657	X11757
Y60	Y11060	Y11160	Y11260	Y11360	Y11460	Y11560	Y11660	Y11760
...
Y67	Y11067	Y11167	Y11267	Y11367	Y11467	Y11567	Y11667	Y11767
Y70	Y11070	Y11170	Y11270	Y11370	Y11470	Y11570	Y11670	Y11770
...
Y76	Y11076	Y11176	Y11276	Y11376	Y11476	Y11576	Y11676	Y11776
Y77	Y11077	Y11177	Y11277	Y11377	Y11477	Y11577	Y11677	Y11777

2-4. I/O specification and wiring

2-4-1. Input specification and wiring

PLC input supports NPN and PNP modes. The internal structure and wiring mode of the two modes are introduced below:

- **Input specification**

Item	Content	
	NPN mode	PNP mode
Input signal voltage	DC24V±10%	DC24V±10%
Input signal current	7mA/DC24V	7mA/DC24V
Input ON current	Above 4.5mA	Above 4.5mA
Input OFF current	Below 1.5mA	Below 1.5mA
Input response time	About 10ms	About 10ms
Input signal format	Contact input or NPN open collector transistor	Contact input or PNP open collector transistor
Circuit insulation	Photoelectric coupling insulation	Photoelectric coupling insulation
Input action display	LED light is on when input on	LED light is on when input on

- **Wiring example**

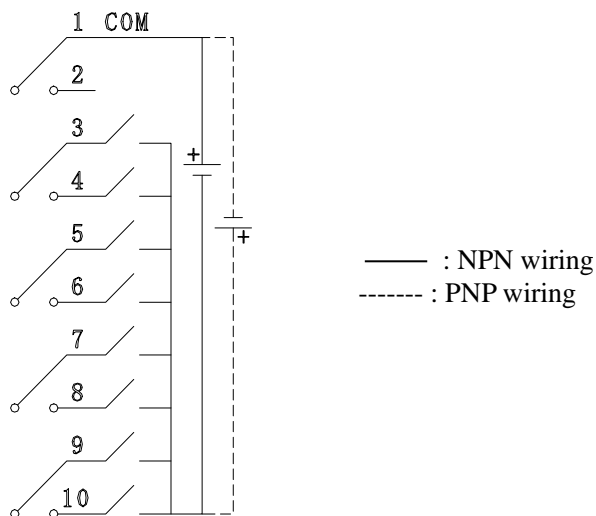

The PLC is generally equipped with a plug-in spring connector to facilitate wiring when it leaves the factory. The length of the stripped wire of this connector is required to be 1.5cm. When wiring, press the orange spring switch with a small screwdriver, insert the wire into the corresponding jack, and release the spring switch.

2-4-2. Output specification and wiring

The output specification is transistor mode. The internal structure and wiring mode of this mode are described below:

(1) Relay output specification and wiring

- Relay output

External power supply		Below AC250V, DC30V
Circuit insulation		Mechanical insulation
Action display		LED light
Max load	Resistive load	3A
	Inductive load	80VA
	Light load	100W
Min load		DC5V 2mA
Response time	OFF→ON	10ms
	ON→OFF	10ms

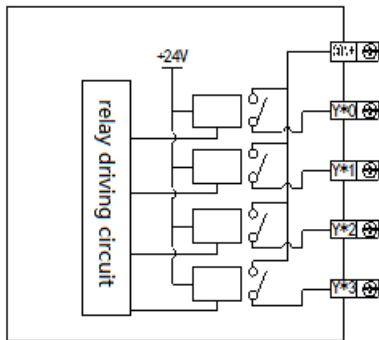

- Relay output processing

Relay output type has 2~4 common terminals. Therefore, each common terminal block unit can drive loads of different power supply voltage systems (such as AC200V, AC100V, DC24V, etc.).

Between the relay output coil and contact, the internal circuit of the programmable controller and the external circuit load circuit are electrically insulated. In addition, the common terminal blocks are also separated from each other.

When the coil of the output relay is powered on, the LED light is on, and the output contact is on.

The response time from the coil of the output relay being energized or cut off to the output contact being on or off is about 10ms.

For current and voltage below AC250V, the output current that can drive pure resistance load is 3A/1 point, inductive load is below 80VA (AC100V or AC200V) and lamp load is below 100W (AC100V or AC200v).

When the output contact is off, there is no leakage current, and the Neon lamp can be directly driven.

Standard life of inductive AC loads such as contactors and solenoid valves: according to the approximate standard of relays obtained from the life test of the company, the load of 20VA is about 500000 times, the load of 35VA is about 300000 times, and the load action life of 80VA is about 100000 times. However, if the load is connected in parallel with the surge absorber, the service life will be significantly prolonged.

- Relay output wiring diagram

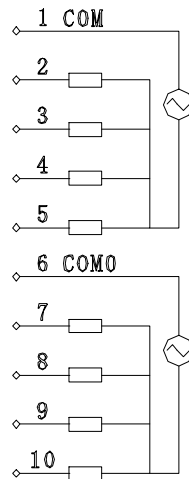

(2) Transistor output specification and wiring

- General transistor output

External power supply		DC5~30V
Circuit insulation		Optocoupler insulation
Action indicator		LED indicator light
Max load	Resistance load	0.3A
	Inductive load	8W/DC24V
	Lamp load	1.5W/DC24V
Min load		DC5V 2mA
Response time	OFF→ON	Below 0.2ms
	ON→OFF	Below 0.2ms

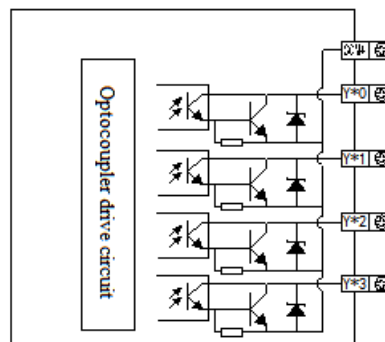

- Transistor output processing

The transistor output of the basic unit has the output of 1~4 common terminals.

Please use DC5~30V regulated power supply for load drive.

The internal circuit of the programmable controller and the output transistor are insulated by optocoupler. In addition, the common end blocks are also separated from each other.

When driving optical coupling, the LED light is on and the output transistor is on.

The time of the programmable controller from the optocoupler drive (or cut-off) to the transistor on (or off) is less than 0.2ms.

The current of each output point is 0.3A. However, due to the limitation of temperature rise, the total current of every 4 output points is 0.5A.

The open circuit current is less than 0.1mA.

- Transistor output wiring diagram

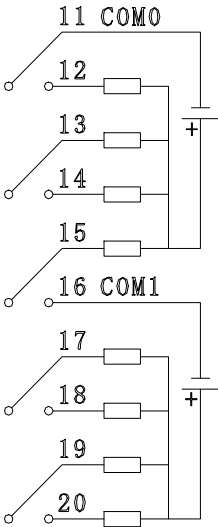

The PLC is generally equipped with a plug-in spring connector to facilitate wiring when it leaves the factory. The length of the stripped wire of this connector is required to be 1.5cm. When wiring, press the yellow spring switch with a small screwdriver, insert the wire into the corresponding jack, and release the spring switch.

2-4-3. Output circuit protection

For the inductive load connected to the AC circuit, the RC instantaneous voltage absorption circuit should be considered for the external circuit. Corresponding to the inductive load of the DC circuit, the freewheeling diode should be considered, as shown in the following figure:

- DC load

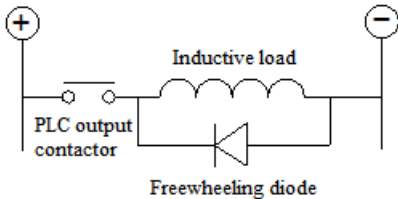

Note: Freewheeling diode is EN4007.

- AC load

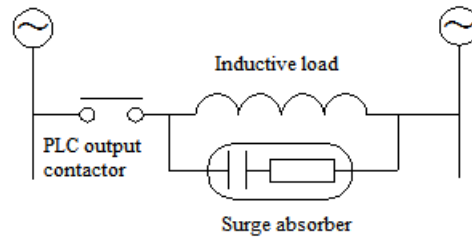

Note: surge absorber $R=200\Omega$ 2W, $C=0.022\mu F$ 250V AC.

2-5. Module parameters

There are two parameters for the module: positive or negative logic, filter time.

There are two setting methods:

- (1) XDPpro software

Open the XDPpro software, click configure/expansion module settings:

Set the model and channel parameters in the following window. Then click write to PLC.

Please restart the PLC after setting.

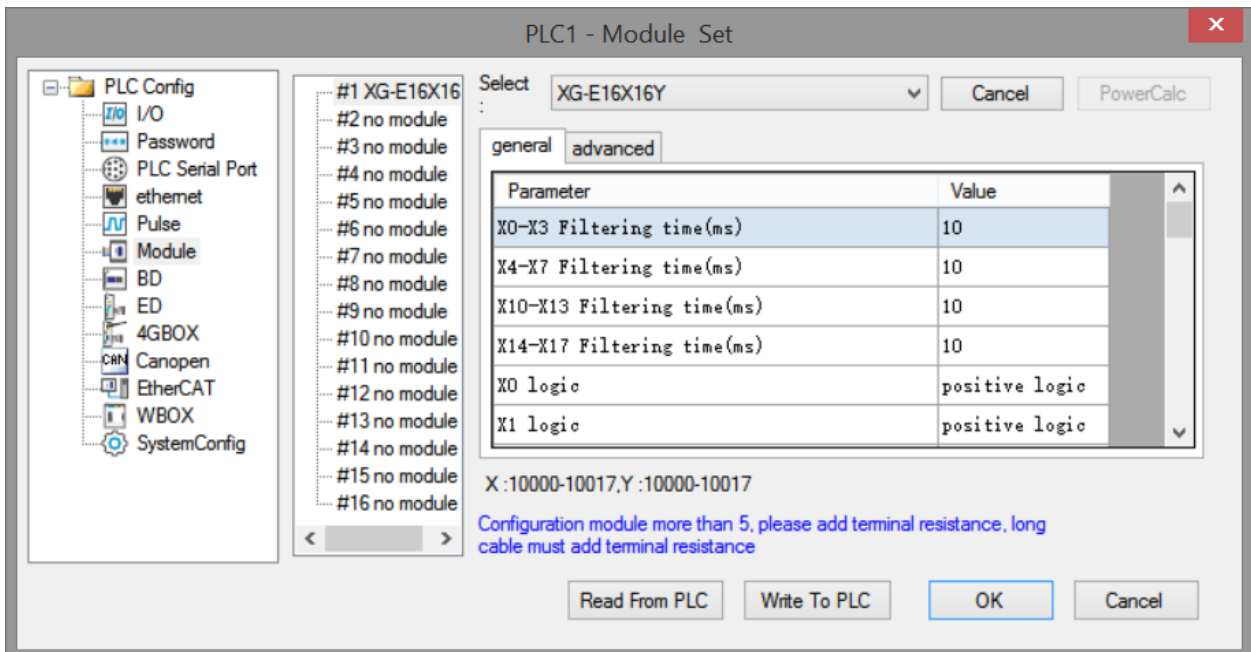

- (2) Set through SFD register

Module no.	SFD address	Module no.	SFD address
#1	SFD350~SFD359	#9	SFD430~SFD439

#2	SFD360~SFD369	#10	SFD440~SFD449
#3	SFD370~SFD379	#11	SFD450~SFD459
#4	SFD380~SFD389	#12	SFD460~SFD469
#5	SFD390~SFD399	#13	SFD470~SFD479
#6	SFD400~SFD409	#14	SFD480~SFD489
#7	SFD410~SFD419	#15	SFD490~SFD499
#8	SFD420~SFD429	#16	SFD500~SFD509

The first 20 bytes definitions:

■ **XG-E8X8YR, XG-E8X8YT**

	Byte0	Byte1	Byte2	Byte3	Byte4	Byte5	Byte6~ Byte19
Bit7	X0~X3 filter time	X4~X7 filter time	-	-	-	-	-
Bit6			X3 logic	X7 logic	Y3 logic	Y7 logic	-
Bit5			-	-	-	-	-
Bit4			X2 logic	X6 logic	Y2 logic	Y6 logic	-
Bit3			-	-	-	-	-
Bit2			X1 logic	X5 logic	Y1 logic	Y5 logic	-
Bit1			-	-	-	-	-
Bit0			X0 logic	X4 logic	Y0 logic	Y4 logic	-
note	filter time (ms) setting range: 1~5, 10, 15, 20, 25, 30, 35, 40, 45, 50. Default value is 10ms.		0 is positive logic 1 is negative logic				-

■ XG-E16X

	Byte0	Byte1	Byte2	Byte3	Byte 4	Byte 5	Byte 6	Byte 7	Byte8~ Byte19
Bit7	X0~X3 filter time	X4~X7 filter time	X10~X13 filter time	X14~X17 Filter time	-	-	-	-	-
Bit6					X3 logic	X7 logic	X13 logic	X17 logic	-
Bit5					-	-	-	-	-
Bit4					X2 logic	X6 logic	X12 logic	X16 logic	-
Bit3					-	-	-	-	-
Bit2					X1 logic	X5 logic	X11 logic	X15 logic	-
Bit1					-	-	-	-	-
Bit0					X0 logic	X4 logic	X10 logic	X14 logic	-
note	filter time (ms) setting range: 1~5, 10, 15, 20, 25, 30, 35, 40, 45, 50. Default value is 10ms.				0 is positive logic 1 is negative logic				-

■ XG-E16X16Y

	Bit0	Bit1	Bit2	Bit3	Bit4	Bit5	Bit6	Bit7	Notes
Byte0	X0~X3 filter time								filter time (ms) setting range: 1~5, 10, 15, 20, 25, 30, 35, 40, 45, 50. Default value is 10ms.
Byte1	X4~X7 filter time								
Byte2	X10~X13 filter time								
Byte3	X14~X17 filter time								
Byte4	X0 logic	-	X1 logic	-	X2 logic	-	X3 logic	-	0 is positive logic 1 is negative logic
Byte5	X4 logic	-	X5 logic	-	X6 logic	-	X7 logic	-	
Byte6	X10 logic	-	X11 logic	-	X12 logic	-	X13 logic	-	
Byte7	X14 logic	-	X15 logic	-	X16 logic	-	X17 logic	-	
Byte8	Y0 logic	-	Y1 logic	-	Y2 logic	-	Y3 logic	-	
Byte9	Y4 logic	-	Y5 logic	-	Y6 logic	-	Y7 logic	-	
Byte10	Y10 logic	-	Y11 logic	-	Y12 logic	-	Y13 logic	-	
Byte11	Y14 logic	-	Y15 logic	-	Y16 logic	-	Y17 logic	-	

Note:

1. User can set the discrete input filter time, the time can be 1, 2, 3, 4, 5, 10, 15, 20, 25, 30, 35, 40, 45, 50. The default filter time is 10ms.
2. User can set the discrete input and output polarity: 0 is positive logic; 1 is negative logic.

2-6. Applications

In this chapter, specific examples of this module will be given. The 16 points PLC of Xinje XG1 series is a slave station with an extension module XG-E8X8YR to communicate with Xinje HMI.

The communication between XG-E8X8YR and TG765.

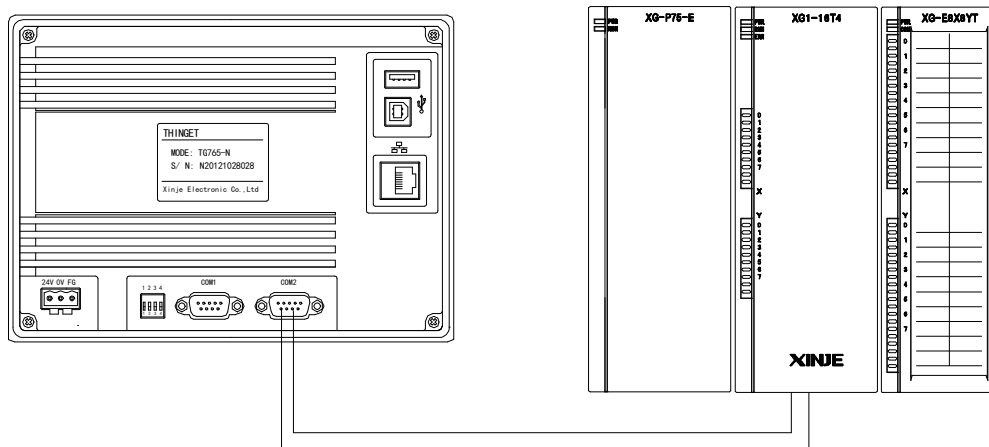

In this example, the HMI is the master station, read the input status of extension module to the HMI, writes the coil status of HMI to the extension module.

- (1) Hardware connection: Connect XG-E8X8YT with XG1-16T4, connect AB terminals of XG1-16T4 to AB terminals (PLC port) of TG765.

Communication parameters setting of PLC:

Baud rate: 19200bps, Data bits: 8bits, Stop bits: 1bit, Parity: even, Modbus number: 1, restart the PLC after setting.

Touchwin software settings for TG765

PLC port device: “Modbus RTU (Panel is master)”, Baud rate: 19200bps, Data bits: 8bits, Stop bits: 1bit, Parity: even.

- (2) Program application:

The corresponding relationship between expansion module address and HMI address:

HMI address	Expansion module	Related MODBUS address
PSB500	X10000	K20736
PSB501	Y10000	K24832

- (3) HMI screen editing:

The screen of HMI:

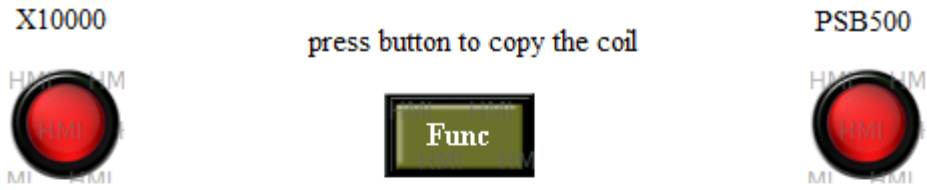

Edit the status of X10000:

Lamp X10000: the Modbus address of expansion module coil X10000 is 0x20736 (diagram A).

Function Button: copy the coil status of X10000 to PSB500 when the button is pressed (diagram B).

Lamp PSB500: HMI internal coil address is PSB500. (diagram C)

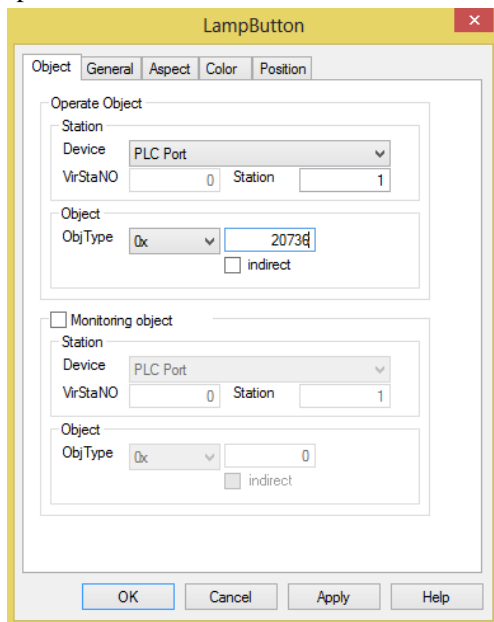

Diagram A

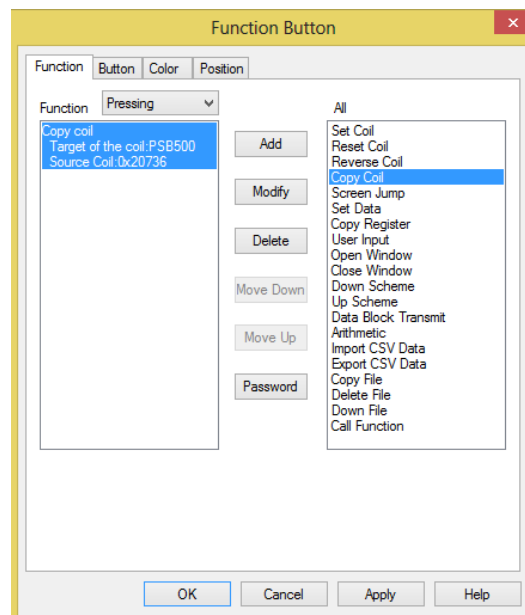

Diagram B

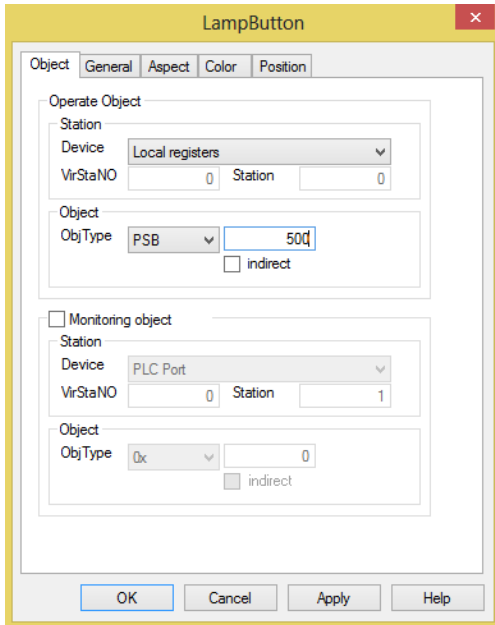

Diagram C

Edit the status of PSB501:

Lamp PSB501: the HMI internal coil address is PSB501 (diagram D);

Function Button: copy the coil status of PSB501 to Y10000 when the button is pressed (diagram E);

Lamp Y10000: the Modbus address of expansion module coil Y10000 is 0x24832 (diagram F).

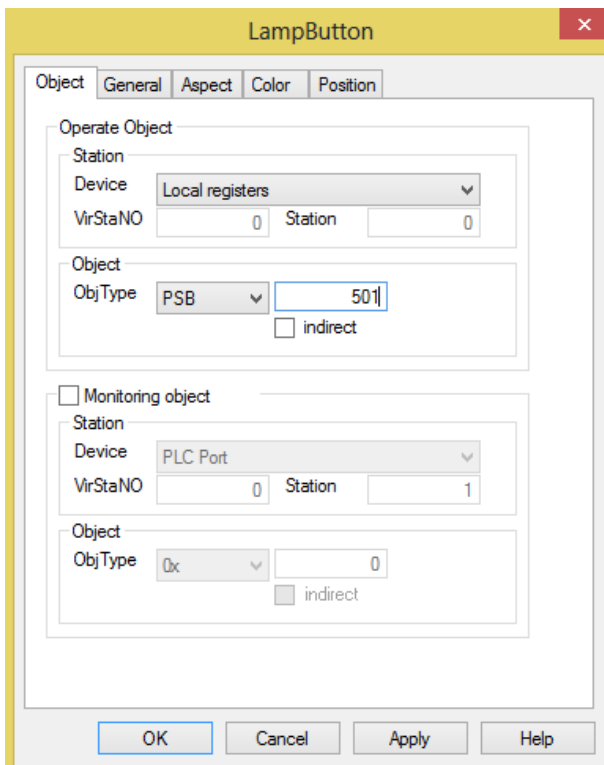

Diagram D

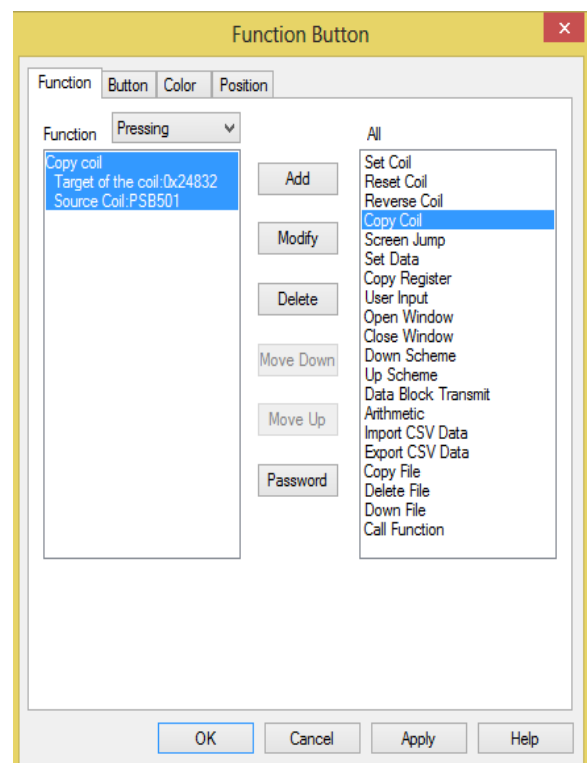

Diagram E

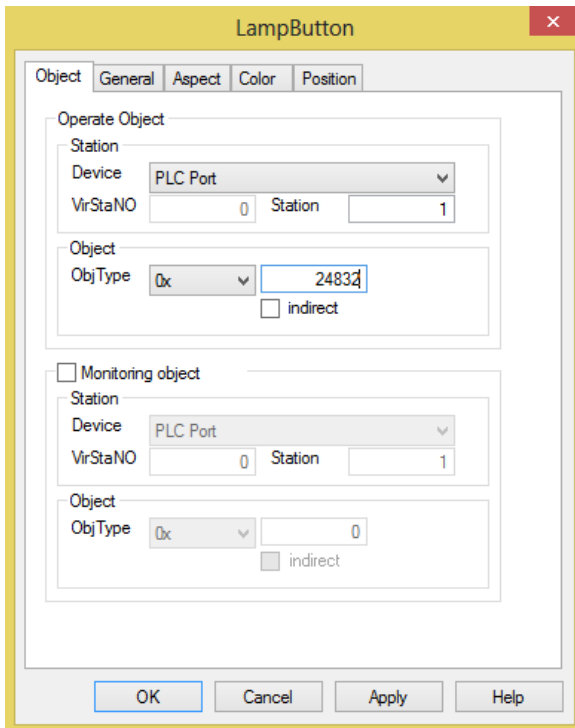

Diagram F

After editing the HMI screen, download it to the HMI and start to work.

3. Analog input/output module XG-E4AD2DA

3-1. Specification

XG-E4AD2DA transform the 4 channels analog value to digital value, 2 channels digital value to analog value, and send them to PLC.

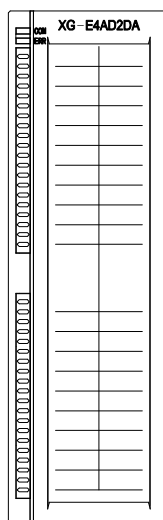

Features:

- 4-channel analog input: voltage input and current input can be selected
- 2 channel analog output
- 14-bit high precision analog input
- As a special function module of XG series, up to 16 modules can be connected on the right side of PLC main body

Module specifications:

Items	Analog input (AD)		Analog output (DA)	
	Voltage input	Current input	Voltage output	Current output
Analog input bound	0~5V, 0~10V, -5~5V, -10~10V (impedance>1M)	0~20mA, 4~20mA, -20~20mA (impedance is about 120 Ω)	-	
Max input bound	DC ±15V	-40~40mA	-	
Analog output bound	-		0~5V, 0~10V, -5~5V, -10~10V (Exterior load resistance 2KΩ~1MΩ)	0~20mA, 4~20mA (Exterior load resistance is less than 500Ω)
Digital input bound	-		12 bits binary data (0~4095 or -2048~2047)	
Digital output bound	14 bits binary data (0~16383 or		-	

	-8192~8191)	
Distinguish ratio	1/16383(14Bit)	1/4095(12Bit)
Integrate precision	± 1%	
Convert speed	2ms per channel	2ms per channel
Power used by analog	DC24V±10%,150mA	
Install format	Directly install on the XG-EB guide rail	
Exterior size	130.0mm×40.0mm×133.4mm	

3-2. Terminals

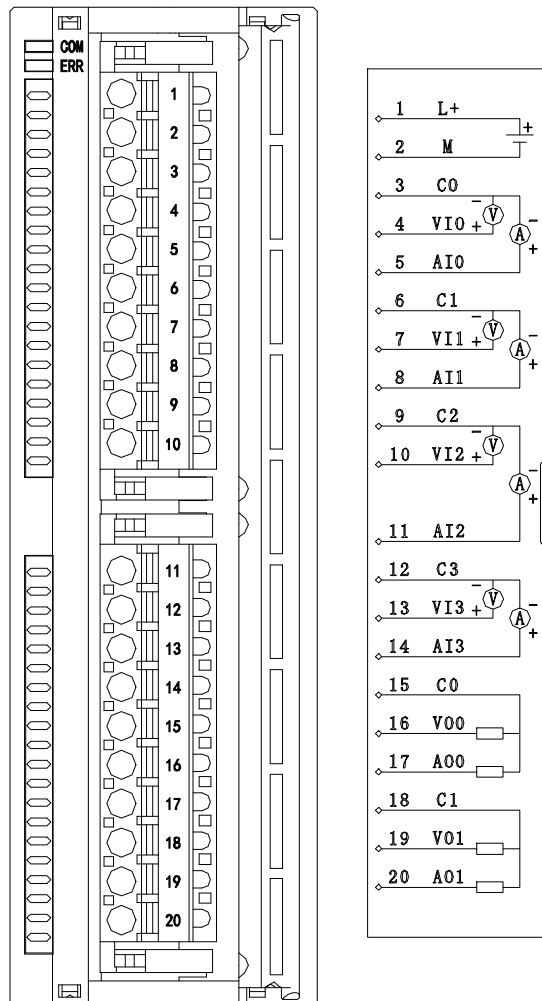

Channel	Terminal name	Signal name
CH0	AI0	Current input
	VI0	Voltage input
	C0	CH0 common terminal of analog input
CH1	AI1	Current input
	VI1	Voltage input

	C1	CH1 common terminal of analog input
CH2	AI2	Current input
	VI2	Voltage input
	C2	CH2 common terminal of analog input
CH3	AI3	Current input
	VI3	Voltage input
	C3	CH3 common terminal of analog input
CH0	AO0	Current output
	VO0	Voltage output
	C0	CH0 common terminal of analog output
CH1	AO1	Current output
	VO1	Voltage output
	C1	CH1 common terminal of analog output
-	L+	+24V power supply
	M	Common terminal of power supply

To avoid interference, please use shielded wire and ground the shielding layer at a single point.

XG series expansion modules are generally equipped with plug-in spring terminal connectors when leaving the factory. The length of wire sheath removal is required to be 1.5cm. When wiring, press the yellow spring switch with a small screwdriver, insert the wire into the corresponding jack, and release the spring switch.

The wiring of XG-E4AD2DA current input side is shown in the following figure:

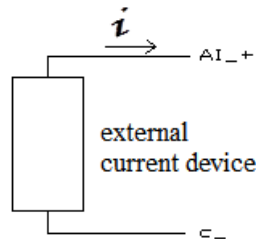

3-3. The assignment of I/O address

XG series analog modules do not occupy I/O units; the converted data is directly transferred into PLC register,

Register address of module1:

Channel	AD signal	Channel enable bit (set ON the bit to use this channel)
0CH	ID10000	Y10000
1CH	ID10001	Y10001
2CH	ID10002	Y10002
3CH	ID10003	Y10003

Channel	DA signal	
0CH	QD10000	Y10004
1CH	QD10001	Y10005

Register address of module2:

Channel	AD signal	Channel enable bit (set ON the bit to use this channel)
0CH	ID10100	Y10100
1CH	ID10101	Y10101
2CH	ID10102	Y10102
3CH	ID10103	Y10103
Channel	DA signal	
0CH	QD10100	Y10104
1CH	QD10101	Y10105

Register address of module3:

Channel	AD signal	Channel enable bit (set ON the bit to use this channel)
0CH	ID10200	Y10200
1CH	ID10201	Y10201
2CH	ID10202	Y10202
3CH	ID10203	Y10203
Channel	DA signal	
0CH	QD10200	Y10204
1CH	QD10201	Y10205

Register address of module4:

Channel	AD signal	Channel enable bit (set ON the bit to use this channel)
0CH	ID10300	Y10300
1CH	ID10301	Y10301
2CH	ID10302	Y10302
3CH	ID10303	Y10303
Channel	DA signal	
0CH	QD10300	Y10304

1CH	QD10301	Y10305
-----	---------	--------

Register address of module5:

Channel	AD signal	Channel enable bit (set ON the bit to use this channel)
0CH	ID10400	Y10400
1CH	ID10401	Y10401
2CH	ID10402	Y10402
3CH	ID10403	Y10403
Channel	DA signal	
0CH	QD10400	Y10404
1CH	QD10401	Y10405

Register address of module6:

Channel	AD signal	Channel enable bit (set ON the bit to use this channel)
0CH	ID10500	Y10500
1CH	ID10501	Y10501
2CH	ID10502	Y10502
3CH	ID10503	Y10503
Channel	DA signal	
0CH	QD10500	Y10504
1CH	QD10501	Y10505

Register address of module7:

Channel	AD signal	Channel enable bit (set ON the bit to use this channel)
0CH	ID10600	Y10600
1CH	ID10601	Y10601
2CH	ID10602	Y10602
3CH	ID10603	Y10603
Channel	DA signal	
0CH	QD10600	Y10604
1CH	QD10601	Y10605

Register address of module8:

Channel	AD signal	Channel enable bit (set ON the bit to use this channel)
0CH	ID10700	Y10700
1CH	ID10701	Y10701
2CH	ID10702	Y10702
3CH	ID10703	Y10703
Channel	DA signal	
0CH	QD10700	Y10704
1CH	QD10701	Y10705

Register address of module9:

Channel	AD signal	Channel enable bit (set ON the bit to use this channel)
0CH	ID10800	Y11000
1CH	ID10801	Y11001
2CH	ID10802	Y11002
3CH	ID10803	Y11003
Channel	DA signal	
0CH	QD10800	Y11004
1CH	QD10801	Y11005

Register address of module10:

Channel	AD signal	Channel enable bit (set ON the bit to use this channel)
0CH	ID10900	Y11100
1CH	ID10901	Y11101
2CH	ID10902	Y11102
3CH	ID10903	Y11103
Channel	DA signal	
0CH	QD10900	Y11104
1CH	QD10901	Y11105

Register address of module11:

Channel	AD signal	Channel enable bit (set ON the bit to use this channel)
0CH	ID11000	Y11200
1CH	ID11001	Y11201
2CH	ID11002	Y11202
3CH	ID11003	Y11203
Channel	DA signal	
0CH	QD11000	Y11204
1CH	QD11001	Y11205

Register address of module12:

Channel	AD signal	Channel enable bit (set ON the bit to use this channel)
0CH	ID11100	Y11300
1CH	ID11101	Y11301
2CH	ID11102	Y11302
3CH	ID11103	Y11303
Channel	DA signal	
0CH	QD11100	Y11304
1CH	QD11101	Y11305

Register address of module13:

Channel	AD signal	Channel enable bit (set ON the bit to use this channel)
0CH	ID11200	Y11400
1CH	ID11201	Y11401
2CH	ID11202	Y11402
3CH	ID11203	Y11403
Channel	DA signal	
0CH	QD11200	Y11404
1CH	QD11201	Y11405

Register address of module14:

Channel	AD signal	Channel enable bit (set ON the bit to use this channel)
0CH	ID11300	Y11500
1CH	ID11301	Y11501
2CH	ID11302	Y11502
3CH	ID11303	Y11503
Channel	DA signal	
0CH	QD11300	Y11504
1CH	QD11301	Y11505

Register address of module15:

Channel	AD signal	Channel enable bit (set ON the bit to use this channel)
0CH	ID11400	Y11600
1CH	ID11401	Y11601
2CH	ID11402	Y11602
3CH	ID11403	Y11603
Channel	DA signal	
0CH	QD11400	Y11604
1CH	QD11401	Y11605

Register address of module16:

Channel	AD signal	Channel enable bit (set ON the bit to use this channel)
0CH	ID11500	Y11700
1CH	ID11501	Y11701
2CH	ID11502	Y11702
3CH	ID11503	Y11703
Channel	DA signal	
0CH	QD11500	Y11704
1CH	QD11501	Y11705

Note:

1. All the above QD registers are double word format.
2. Disable the unused channel to improve the I/O scanning speed.
3. If set off the enable bit of the input channel, this channel will not accept the data. (the data display is 0).
4. If set off the enable bit of the output channel, this channel will keep the former data.

3-4. Working mode

There are two ways to set the working mode:

1. XDPpro software
2. Flash registers of PLC

XDPpro software:

Open the XGPpro software, click configure/expansion module settings.

Set the model and channel parameters in the following window. Then click write to PLC.

Please restart the PLC after setting.

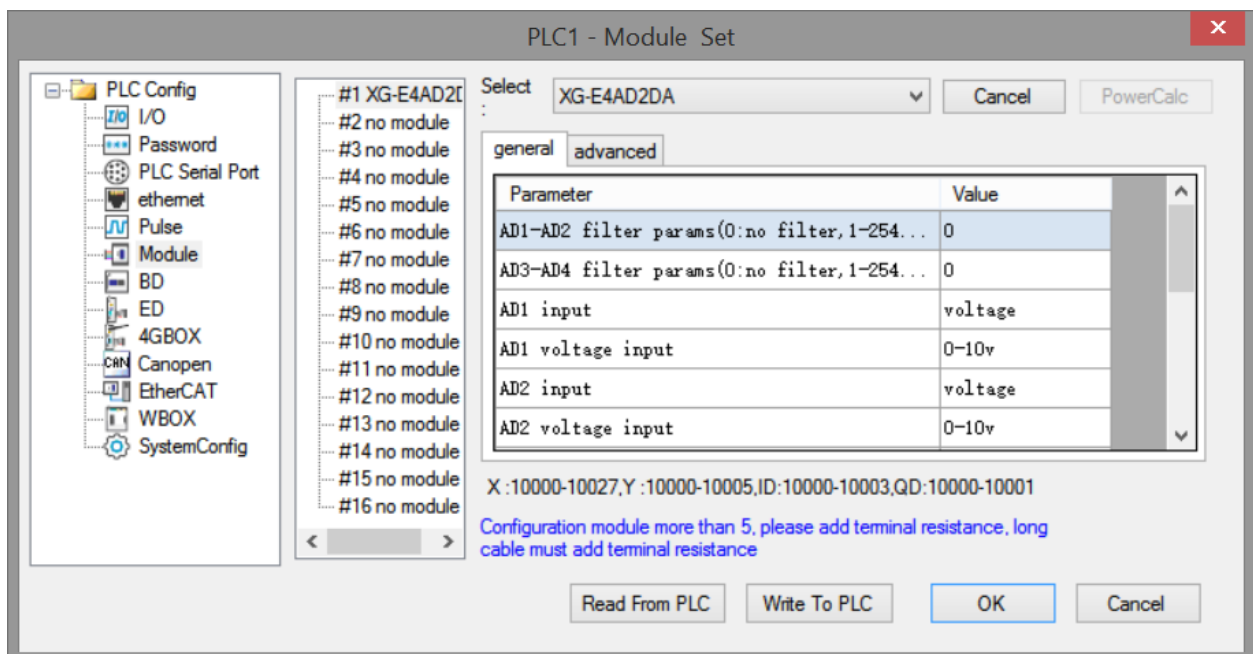

Note:

1. The first-order low-pass filtering method uses this sampling value and the last filtering output value for weighting to get the effective filtering value. The filter parameter can be set to 0~254, default is 0 (no filter).
2. Please use XDPpro software version v3.5.1 and up.

Flash registers:

The module has current and voltage mode. Current has choices of 0~20mA, 4~20mA; voltage has choices of 0~5V, 0~10V. These parameters can be set through SFD registers.

Module no.	SFD address	Module no.	SFD address
#1	SFD350~SFD359	#9	SFD430~SFD439
#2	SFD360~SFD369	#10	SFD440~SFD449
#3	SFD370~SFD379	#11	SFD450~SFD459
#4	SFD380~SFD389	#12	SFD460~SFD469
#5	SFD390~SFD399	#13	SFD470~SFD479
#6	SFD400~SFD409	#14	SFD480~SFD489
#7	SFD410~SFD419	#15	SFD490~SFD499
#8	SFD420~SFD429	#16	SFD500~SFD509

Note: As shown in the preceding table, every register set 4 channels mode, each register has 16 bits, from low to high, every 4 bits set 1 channel mode.

SFD register bit definition:

Module no.1:

	Bit7	Bit6	Bit5	Bit4	Bit3	Bit2	Bit1	Bit0
Byte0	AD channel 1, channel 2 filter time							
Byte1	AD channel 3, channel 4 filter time							
Byte2	Bit7	Bit6	Bit5	Bit4	Bit3	Bit2	Bit1	Bit0
	AD2				AD1			
	-	-	0: voltage input 1: current input	0: 0~10V 1: 0~5V 0: 0~20mA 1: 4~20mA	-	-	0: voltage input 1: current input	0: 0~10V 1: 0~5V 0: 0~20mA 1: 4~20mA
Byte3	Bit7	Bit6	Bit5	Bit4	Bit3	Bit2	Bit1	Bit0
	AD4				AD3			
	-	-	0: voltage input 1: current input	0: 0~10V 1: 0~5V 0: 0~20mA 1: 4~20mA	-	-	0: voltage input 1: current input	0: 0~10V 1: 0~5V 0: 0~20mA 1: 4~20mA
Byte4	Bit7	Bit6	Bit5	Bit4	Bit3	Bit2	Bit1	Bit0

	DA2				DA1			
	-	-	0: voltage input 1: current input	0: 0~10V 1: 0~5V 0: 0~20mA 1: 4~20mA	-	-	0: voltage input 1: current input	0: 0~10V 1: 0~5V 0: 0~20mA 1: 4~20mA
Byte5~ Byte19	-							

For example:

Set the module no.1 AD channel 3, 2, 1, 0 working mode to 0~20mA, 4~20mA, 0~10V, 0~5V. Set the channel 1 and 2 filter factor to 254, set the channel 3 and 4 filter factor to 100. Set DA channel 1 and 0 working mode to 0~10V, 0~20mA.

So the SFD register values are:

SFD350=64FEH SFD351=64H SFD352=0030H SFD353=23H SFD354=2H

Advanced configuration:

Click advanced to do advanced setting for the module including AD calibration, unit display conversion, free range, alarm upper/lower limit, traffic accumulation.

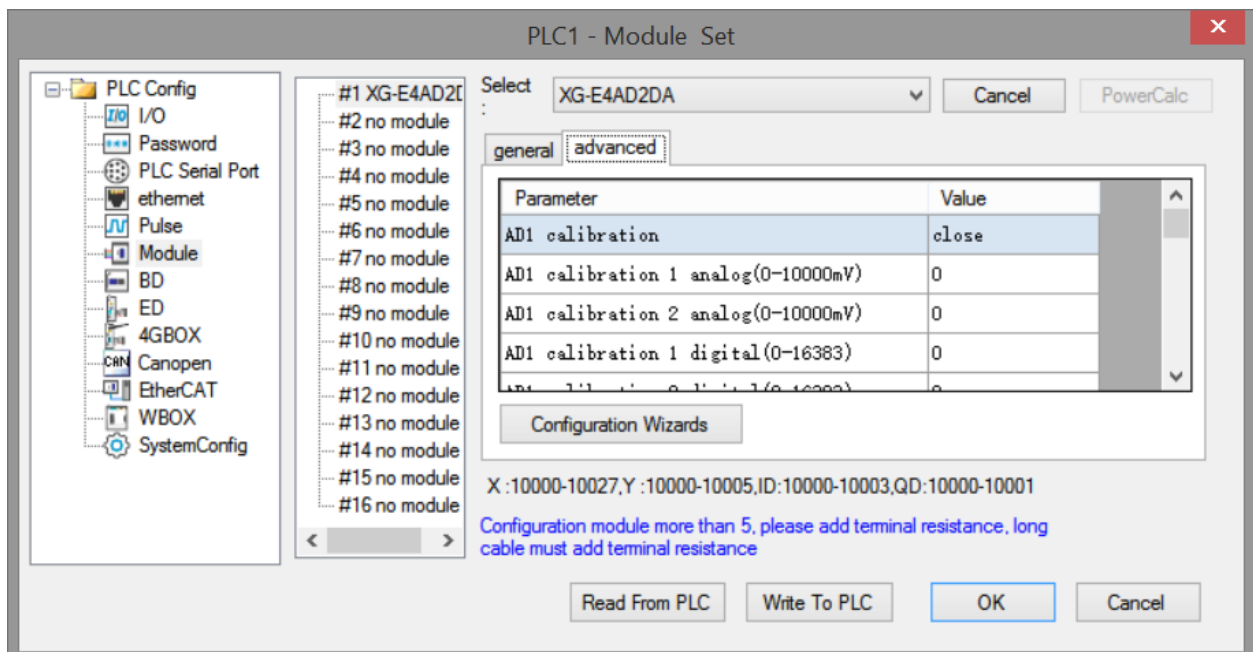

Advanced configuration information distribution:

Name	AD calibration enable bit	Calibration 1 analog value (mV/uA)	Calibration 1 Digital value	Calibration 2 analog value (mV/uA)	Calibration 2 Digital value
Occupied bit description	1bit/AD bit	16bit	32bit	16bit	32bit
Occupied word	1	1	2	1	2
Bit description	-	Unit conversion enable bit	Unit conversion upper limit	Unit conversion lower limit	-
Occupied bit description	-	1bit/AD bit	32bit	32bit	-
Occupied word	-	1	2	2	-
Name	Up upper limit alarm value	Up lower limit alarm value	Down upper limit alarm value	Down lower limit alarm value	-
Occupied bit description	32bit	32bit	32bit	32bit	-
Occupied word	2	2	2	2	-
Name	Free range enable bit	Free range upper limit analog value mV/uA	Free range upper limit digital value	Free range lower limit analog value mV/uA	Free range upper limit digital value
Occupied bit description	1bit/AD bit	16bit	32bit	16bit	32bit
Occupied word	1	1	2	1	2
Name	-	Traffic accumulation enable bit	Traffic accumulation cycle	Traffic time unit conversion	Unit magnification
Occupied bit description	-	1bit/AD bit	16bit	16bit	16bit
Occupied word	-	1	1	1	1

The execution process of the above functions is:

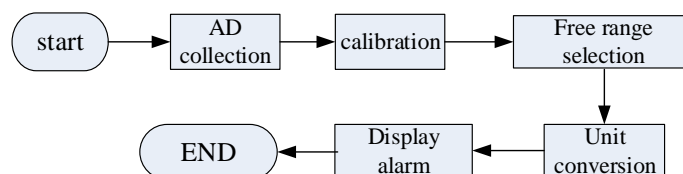

Calibration:

Since AD sampling will be offset after long-term use, the user can start calibration, input two measured values at this time (analog unit mV and digital quantity before calibration), and the expansion module will adjust the offset according to this situation.

User input: first open the calibration enable bit of the corresponding channel, and then input the first value analog quantity A1 and the corresponding digital quantity D1 at this time, and the second analog quantity A2 and the corresponding digital quantity D2 at this time, so as to carry out calibration.

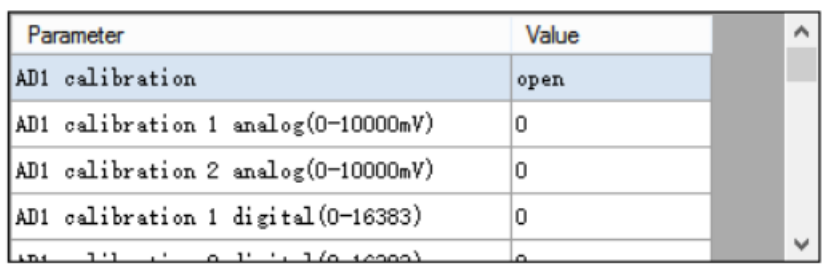

Parameter	Value
AD1 calibration	open
AD1 calibration 1 analog(0-10000mV)	0
AD1 calibration 2 analog(0-10000mV)	0
AD1 calibration 1 digital(0-16383)	0
AD1 calibration 2 digital(0-16383)	0

Free range:

Users can limit the sampling range (analog input, amplification of 1000 times integer data) through this mode. If the limit value is exceeded, the digital quantity will be automatically limited to the upper and lower limits.

The user turns on the channel free range enable bit, and then enters the analog value of the upper and lower limits of the range. The module automatically limits it to the corresponding digital value.

Assuming that the input range of AD1 channel is 0~10V, now the user wants to set the free range to 1~5V, and the corresponding digital quantity is 1000~10000, then the settings are as follows:

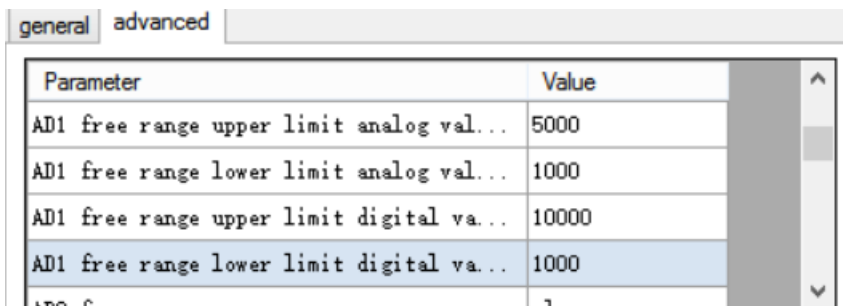

Parameter	Value
AD1 free range upper limit analog val...	5000
AD1 free range lower limit analog val...	1000
AD1 free range upper limit digital va...	10000
AD1 free range lower limit digital va...	1000

The upper limit analog value of free range is set to 5000, the lower limit analog value is set to 1000, the upper limit digital value is set to 10000, and the low limit digital value is set to 1000. When the input voltage exceeds 5V, the corresponding digital quantity display is still 10000.

Unit display conversion:

This function is provided to facilitate customers to directly convert the collected analog quantity into the actual output unit of the required sensor. The user can manually configure the converted upper limit unit value and the corresponding lower limit unit value (if the free range is enabled, it is for the upper and lower limits after free conversion).

For example, set the unit as the pressure sensor unit Mp, and set 0~5V to correspond to 0~10Mp, which can be set as follows:

Parameter	Value
AD1-AD2 filter params(0:no filter, 1-254...	0
AD3-AD4 filter params(0:no filter, 1-254...	0
AD1 input	voltage
AD1 voltage input	0-5v
AD2 input	voltage
AD2 voltage input	0-10v

Parameter	Value
AD1 unit display conversion	open
AD1 unit display conversion upper limit	10
AD1 unit display conversion lower limit	0
AD2 unit display conversion	close

Note: If the free range is set, the analog quantity shall be subject to the free range setting range.

Alarm upper/lower limit value:

When the digital operation value is in the preset range (the part shown by the thick line in the figure), the alarm is output. As shown in the following figure, this function is only for AD channel and can be configured through programming software.

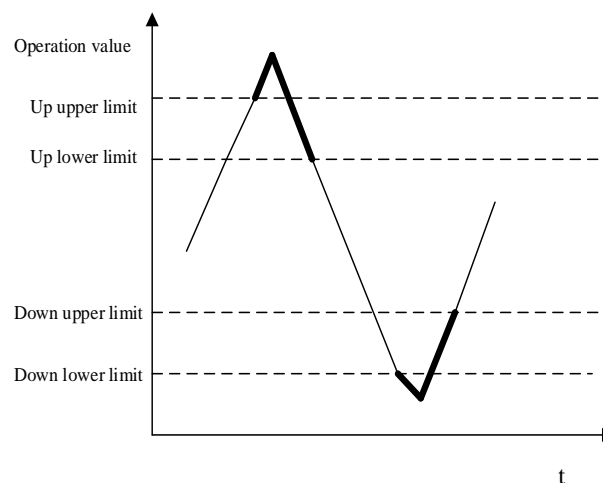

Parameter	Value
AD1 alarm upper and upper limit value	0
AD1 alarm upper and lower limit value	0
AD1 alarm lower and upper limit value	0
AD1 alarm lower and lower limit value	0

Traffic accumulation:

Parameter	Value
AD1 traffic accumulation	close
AD1 accumulation cycle(0~65535ms)	0
AD1 cumulative time unit conversion	second
AD1 unit magnification	1

Accumulation cycle: range 0~65535, unit: ms.

Cumulative time unit conversion: the cumulative period (ms by default) can be converted to seconds, minutes and hours.

Unit magnification: the range is 1, 10, 100, 1000, 10000, and the default is 1.

The above parameters can be set through the configuration panel shown in the above figure.

The formula for AD channel to realize traffic accumulation is:

$$Sum = CurrentFlow \times \frac{\Delta T}{T} \times rate + LastSum$$

In this formula,

Sum: Cumulative value this time,

CurrentFlow: Instantaneous flow, digital quantity collected by AD

ΔT : Accumulation cycle/ms, user input, range is 0~65535,

T: Unit conversion value, 1,10,100,1000,10000.

If you need to clear the cumulative flow, you can turn on the Y1001n corresponding to channel n, and then clear the cumulative value.

3-5. AD conversion diagram

The relationship between analog input and corresponding digital value:

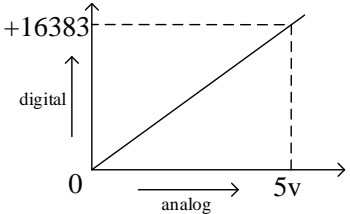
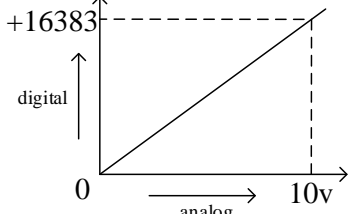
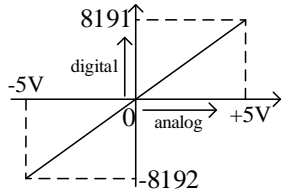
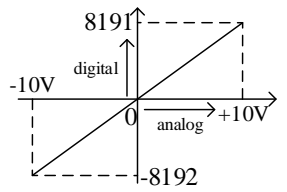
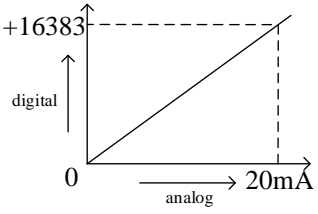
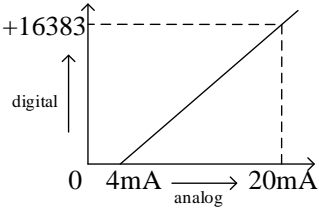
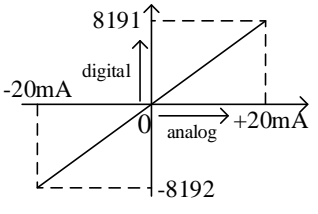
<p style="text-align: center;">0~5V analog input</p> 	<p style="text-align: center;">0~10V analog input</p> 
<p style="text-align: center;">-5~5V analog input</p> 	<p style="text-align: center;">-10~10V analog input</p> 
<p style="text-align: center;">0~20mA analog input</p> 	<p style="text-align: center;">4~20mA analog input</p> 
<p style="text-align: center;">-20~20mA analog input</p> 	

The relationship between digital output value and corresponding analog value:

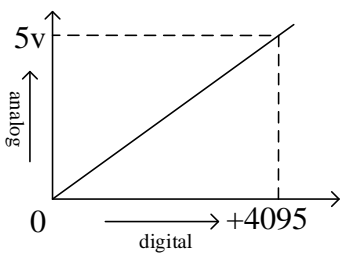
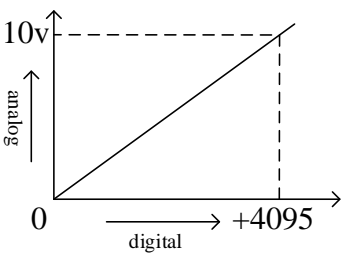
<p style="text-align: center;">0~5V analog output</p> 	<p style="text-align: center;">0~10V analog output</p> 
<p style="text-align: center;">-5~5V analog output</p>	<p style="text-align: center;">-10~10V analog output</p>

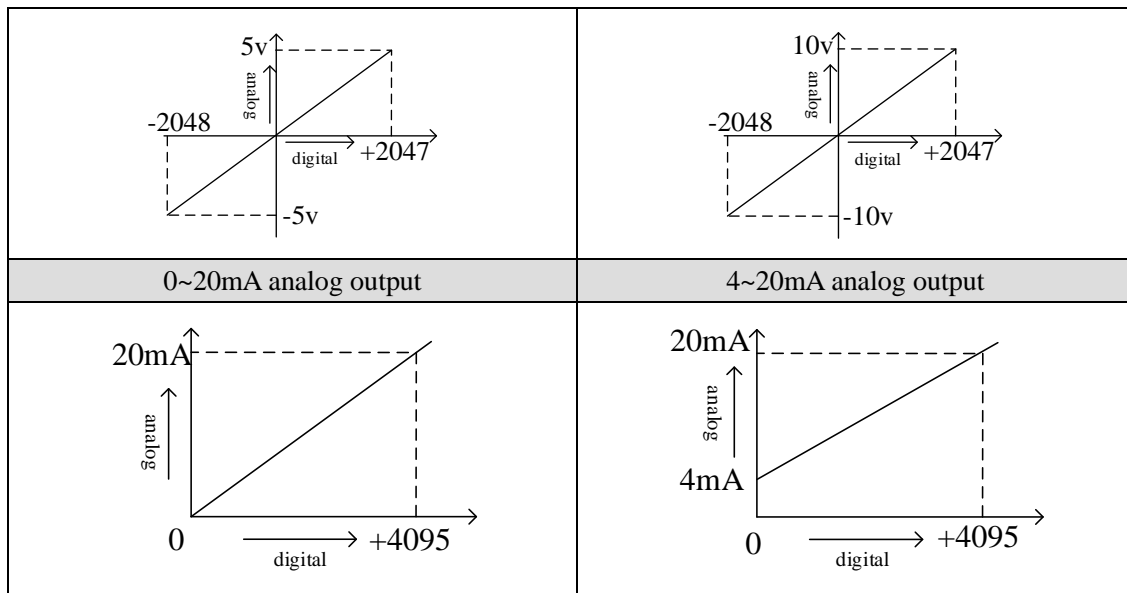

Note: When input data exceeds 4095, analog output will keep the max value of 5V, 10V or 20mA.

3-6. Programming

Example:

The output signal of the existing pressure sensor needs to be collected (pressure sensor performance parameters: detection pressure range of 0MP ~ 10MP, output analog signal of 4 ~ 20mA), and a 0V ~ 10V voltage signal needs to be output to the inverter.

Analysis:

Since the pressure detection range of the pressure sensor is 0MP ~ 10MP, the corresponding output analog quantity is 4~20mA, and the digital quantity range converted by the expansion module through analog-to-digital conversion is 0~16383; therefore, we can skip the analog quantity 4~20mA in the intermediate conversion link, then the pressure detection range is 0MP ~ 10MP, the corresponding digital quantity range is 0 ~ 16383; $10\text{MP} / 16383 = 0.000610388$. So as long as the real-time value collected in the ID register of the expansion module is multiplied by 0.000610388, the real-time pressure of the current pressure sensor can be calculated; for example, if the number collected in the ID register is 4095, the corresponding pressure is 2.5MP.

Similarly, the range of digital value set in the register QD of the expansion module is 0 ~ 4095, which corresponds to the voltage output signal 0V ~ 10V, and $10\text{V} / 4095 = 0.002442$ indicates how much voltage value is output for each digital value set in the register QD of the expansion module; for example, 3V voltage value needs to be output now, $3\text{V} / 0.002442 = 1228.5$, and the calculated digital value is sent to the corresponding QD register.

Note: please use floating-point operation for calculation, otherwise the calculation accuracy will be affected or even unable to calculate!

The program:

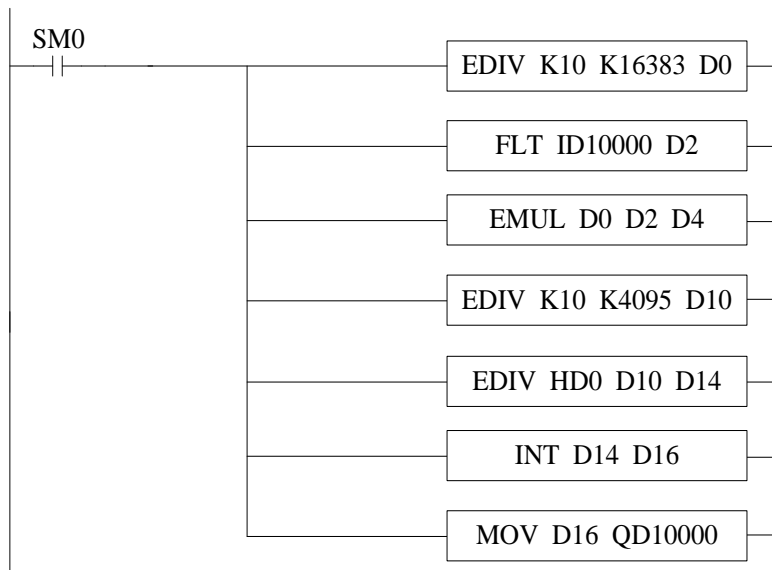

Explanation:

SM0 is normally on coil, which is always on during PLC operation.

When PLC starts to run, analog quantity acquisition first calculates the pressure value corresponding to each digit 1 of the digital quantity collected by the expansion module, and then converts the digital quantity (integer) collected in ID10000 register into floating-point number. The real-time value collected in ID10000 register of the expansion module multiplied by the pressure value corresponding to each digit 1 of the digital quantity collected by the expansion module is the real-time pressure value.

Similarly, the analog output first calculates the voltage value corresponding to each digit 1 of the digital quantity collected by the expansion module, divides the set target voltage value by the digital quantity corresponding to each digit 1 can get the digital quantity (floating-point number) to be set. Since QD10000 register can only store integers, it is necessary to convert the floating-point number to integer and send to QD10000.

Note: please turn on the enable bit of the used channel, that is, set Y10000 and Y10004 to on.

4. Analog input module XG-E8AD-A-S

4-1. Specification

XG-E8AD-A-S transform the analog value (current input) to digital value and send to PLC registers.

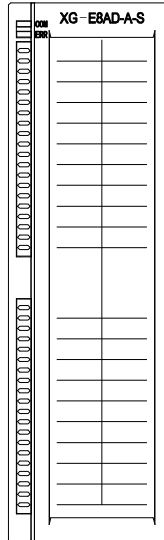

Features:

- 8-channel analog input: current input. 0~20mA, 4~20mA, -20~20mA optional.
- 16-bit high precision analog input.
- As a special function module of XG series, up to 16 modules can be connected on the right side of PLC body.

Specifications:

Items	Current input
Analog input range	0~20mA, 4~20mA, -20~20mA
Max input range	-40~40mA
Digital output range	16 bits binary data (0~65535 or -32768~32767)
Resolution	1/65535(16Bit)
Integrate Precision	±1%
Conversion speed	2ms per channel
Analog power supply	DC24V±10%,150mA
Installation	Directly install on the XG-EB series guide rail
Dimension	130.0mm×40.0mm×133.4mm

4-2. Terminals

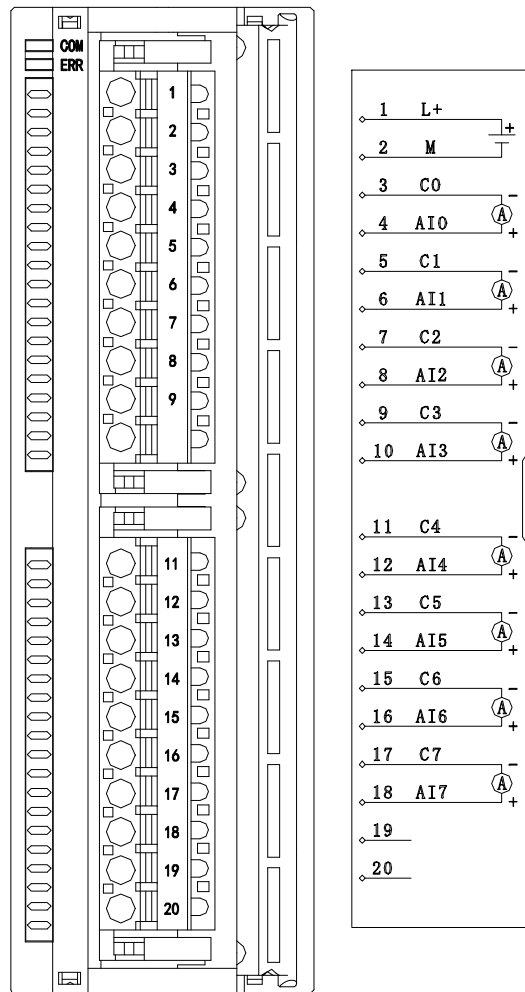

Channel	Terminal name	Signal name
CH0	AI0	Current input
	C0	CH0 input common terminal
CH1	AI1	Current input
	C1	CH1 input common terminal
CH2	AI2	Current input
	C2	CH2 input common terminal
CH3	AI3	Current input
	C3	CH3 input common terminal
CH4	AI4	Current input
	C4	CH4 input common terminal
CH5	AI5	Current input

	C5	CH5 input common terminal
CH6	AI6	Current input
	C6	CH6 input common terminal
CH7	AI7	Current input
	C7	CH7 input common terminal
-	L+	+24V power supply
	M	Common terminal of power supply

To avoid interference, please use shielded wire and ground the shielding layer at a single point.

XG series expansion modules are generally equipped with plug-in spring terminal connectors when leaving the factory. The length of wire sheath removal is required to be 1.5cm. When wiring, press the yellow spring switch with a small screwdriver, insert the wire into the corresponding jack, and release the spring switch.

The wiring of XG-E8AD-A-S current input side is shown in the following figure:

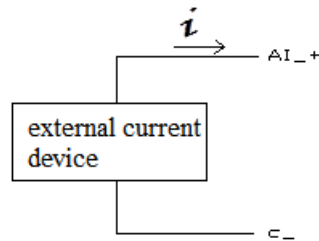

4-3. I/O distribution

XG series analog expansion modules don't occupy I/O unit, the converted data is directly transferred to PLC register. Each channel address:

Note: each channel can only be used when the enable bit is turned on.

Parameter	Address				
	Channel	CH0	CH1	CH7
Module fault alarm	Module 1	X10000	X10001	X1000×	X10007
	Module 2	X10100	X10101	X1010×	X10107
	...	X10x00	X10x01	X10x0×	X10x07
	Module 16	X11700	X11701	X1170×	X11707
Upper limit alarm*	Module 1	X10010	X10011	X1001×	X10017
	Module 2	X10110	X10111	X1011×	X10117
	...	X10x10	X10x11	X10x1×	X10x17
	Module 16	X11710	X11711	X1171×	X11717
Lower limit alarm*	Module 1	X10020	X10021	X1002×	X10027
	Module 2	X10120	X10121	X1012×	X10127
	...	X10x20	X10x21	X10x2×	X10x27
	Module 16	X11720	X11721	X1172×	X11727
Enable bit	Module 1	Y10000	Y10001	Y1000×	Y10007
	Module 2	Y10100	Y10101	Y1010×	Y10107

	...	Y10x00	Y10x01	Y10x0×	Y10x07
	Module 16	Y11700	Y11701	Y1170×	Y11707
Traffic accumulative enable bit *	Module 1	Y10010	Y10011	Y1001×	Y10017
	Module 2	Y10010	Y10011	Y1001×	Y10017
	...	Y10x10	Y10x11	Y10x1×	Y10x17
	Module 16	Y11710	Y11711	Y1171×	Y11717
Output value (double word)	Module 1	ID10000	ID10002	ID1000×	ID10014
	Module 2	ID10100	ID10102	ID1010×	ID10114
	...	ID10x00	ID10x02	ID10x0×	ID10x14
	Module 16	ID11500	ID11502	ID1150×	ID11514
Original value display* (double word)	Module 1	ID10016	ID10018	ID100×	ID10030
	Module 2	ID10116	ID10118	ID101×	ID10130
	...	ID10x16	ID10x18	ID10x×	ID10x30
	Module 16	ID11516	ID11518	ID115×	ID11530
Traffic accumulation* (double word)	Module 1	ID10032	ID10034	ID100×	ID10046
	Module 2	ID10132	ID10134	ID101×	ID10146
	...	ID10x32	ID10x34	ID10x×	ID10x46
	Module 16	ID11532	ID11534	ID115×	ID11546

Note:

1. Since the register is displayed the signed value, the 16 bits unsigned number will be stored in double word form.
2. Forbid the unused channel to improve the I/O scanning speed.
3. If set off the enable bit of the channel, this channel will not accept the data. (the data display is 0).
4. Module fault alarm is used to alarm when the module has faults such as input out of range, wiring open circuit, short circuit, etc. When the above faults occur in the AD channel, its corresponding fault alarm X1001x will be set to on.
5. The parameters marked with * are advanced function parameters. Refer to "advanced configuration" in chapter 4-4 working mode setting for details.

4-4. Working mode

There are two ways to set the working mode:

1. XDPpro software
2. Flash registers of PLC

XDPpro software:

Open the XDPpro software, click configure/expansion module settings:

Set the model and channel parameters in the following window. Then click write to PLC.

Please restart the PLC after setting.

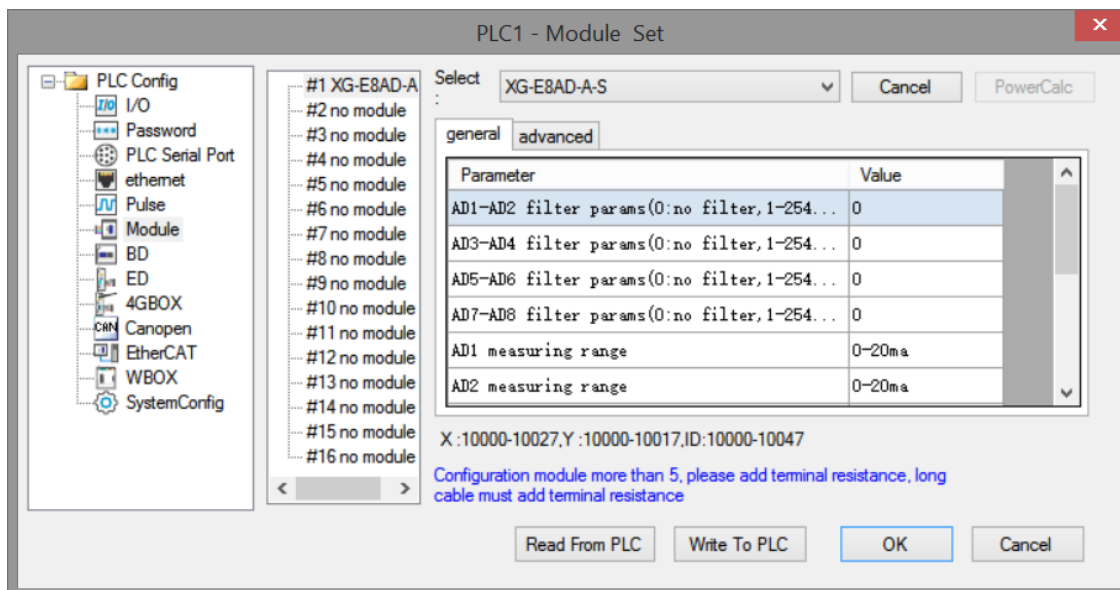

Note:

1. The first-order low-pass filtering method uses this sampling value and the last filtering output value for weighting to get the effective filtering value. The filter parameters can be set to 0~254, default value 0 is no filter.
2. Please use PLC programming software XDPpro v3.5.1 and up.

Flash registers:

The module input is current mode, the current range include 0~20mA, 4~20mA, -20~20mA. Set the modes through SFD registers of PLC. See the following table:

Module no.	SFD address	Module no.	SFD address
#1	SFD350~SFD359	#9	SFD430~SFD439
#2	SFD360~SFD369	#10	SFD440~SFD449
#3	SFD370~SFD379	#11	SFD450~SFD459
#4	SFD380~SFD389	#12	SFD460~SFD469
#5	SFD390~SFD399	#13	SFD470~SFD479
#6	SFD400~SFD409	#14	SFD480~SFD489
#7	SFD410~SFD419	#15	SFD490~SFD499

#8	SFD420~SFD429	#16	SFD500~SFD509
----	---------------	-----	---------------

Note: each SFD register can set 4 channels mode. Each register has 16 bits, every 4 bits set four channels mode.

SFD bit definition:

The configuration information occupies the first 20 bytes of the address, and the specific allocation of the address is shown in the following table:

	Bit7	Bit6	Bit5	Bit4	Bit3	Bit2	Bit1	Bit0
Byte0	AD channel 1 and channel 2 filter time							
Byte1	AD channel 3 and channel 4 filter time							
Byte2	AD channel 5 and channel 6 filter time							
Byte3	AD channel 7 and channel 8 filter time							
Byte4	AD2				AD1			
	-	010: 0~20mA 011: 4~20mA 110: -20~20mA			-	010: 0~20mA 011: 4~20mA 110: -20~20mA		
Byte5	AD4				AD3			
	-	010: 0~20mA 011: 4~20mA 110: -20~20mA			-	010: 0~20mA 011: 4~20mA 110: -20~20mA		
Byte6	AD6				AD5			
	-	010: 0~20mA 011: 4~20mA 110: -20~20mA			-	010: 0~20mA 011: 4~20mA 110: -20~20mA		
Byte7	AD8				AD7			
	-	010: 0~20mA 011: 4~20mA 110: -20~20mA			-	010: 0~20mA 011: 4~20mA 110: -20~20mA		
Byte8~byte19	-							

Advanced configuration:

Click advanced to do advanced setting for the module including AD calibration, unit display conversion, free range, alarm upper/lower limit, traffic accumulation.

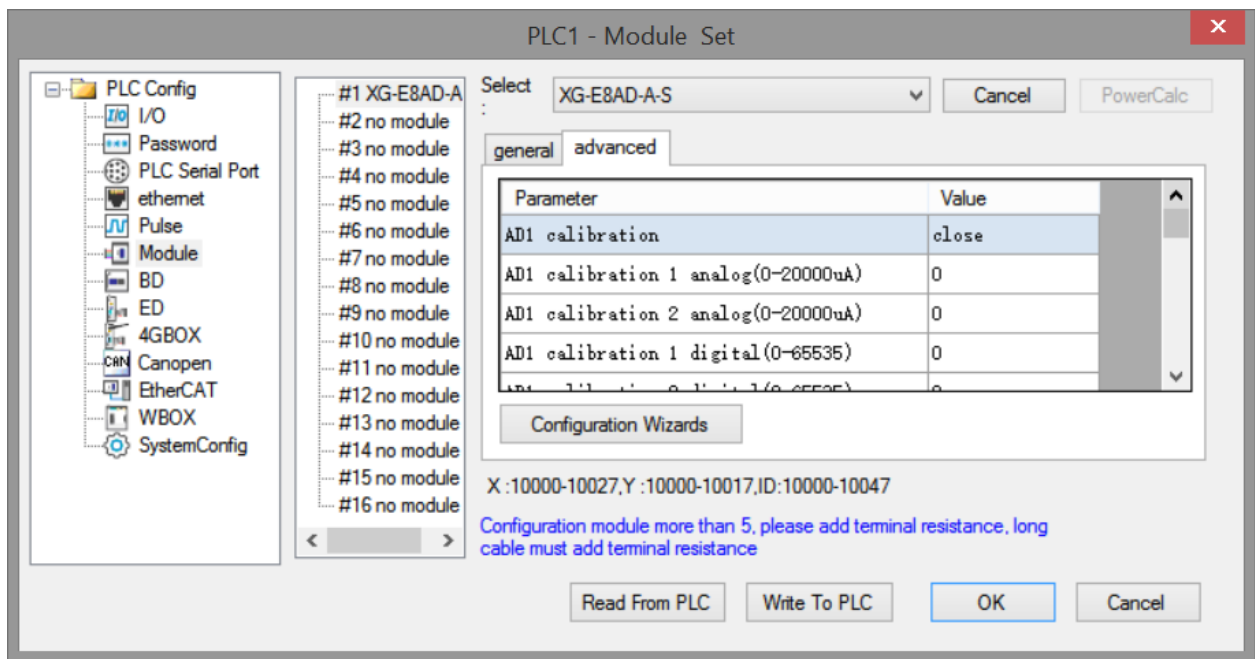

Advanced configuration information distribution:

Bit	AD calibration enable bit	Calibration current 1 analog value (uA)	Calibration current 1 digital value	Calibration current 2 analog value (uA)	Calibration current 2 digital value
Occupied bit description	1BIT/AD bit	INT16S	INT32S	INT16S	INT32S
Occupied word	1	1	2	1	2
Bit description	-	Unit conversion enable bit	Unit conversion upper limit	Unit conversion lower limit	-
Occupied bit description	-	1BIT/AD bit	INT32S	INT32S	-
Occupied word	-	1	2	2	-
Bit description	Up upper limit alarm value	Up lower limit alarm value	Down upper limit alarm value	Down lower limit alarm value	-
Occupied bit description	INT32S	INT32S	INT32S	INT32S	-
Occupied word	2	2	2	2	-
Bit description	Free range enable bit	Free range upper limit analog value uA	Free range upper limit digital value	Free range lower limit analog value uA	Free range upper limit digital value

Occupied bit description	1BIT/AD bit	INT16S	INT32S	INT16S	INT32S
Occupied word	1	1	2	1	2
Bit description	-	Traffic accumulation enable bit	Traffic accumulation cycle	Flow time coefficient	Scale factor
Occupied bit description	-	1BIT/AD bit	INT16U	INT16U	INT16U
Occupied word	-	1	1	1	1

The execution process of the above functions is:

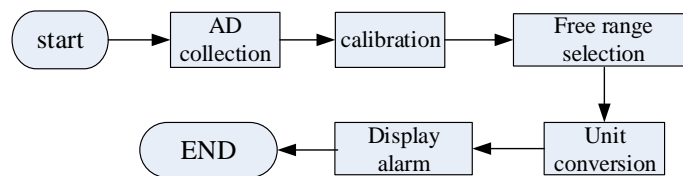

Calibration:

Since AD sampling will be offset after long-term use, the user can start calibration, input two measured values at this time (analog unit uA and digital quantity before calibration), and the expansion module will adjust the offset according to this situation.

User input: first open the calibration enable bit of the corresponding channel, and then input the first value analog quantity A1 and the corresponding digital quantity D1 at this time, and the second analog quantity A2 and the corresponding digital quantity D2 at this time, so as to carry out calibration.

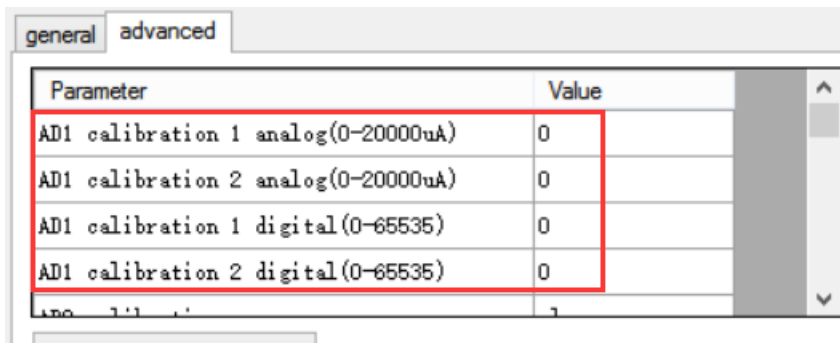

Free range:

Users can limit the sampling range (analog input, amplification of 1000 times integer data) through this mode. If the limit value is exceeded, the digital quantity will be automatically limited to the upper and lower limits.

The user turns on the channel free range enable bit, and then enters the analog value of the upper and lower limits of the range. The module automatically limits it to the corresponding digital value.

Assuming that the user sets the channel input range to 0~20mA, the upper limit analog value of free range to 1000, and the lower limit analog value to 5000, it means that the limited sampling range is 1~5mA. If the input

current exceeds 5mA, the corresponding digital quantity display is still 16383.

Parameter	Value
AD1 free range upper limit analog val...	0
AD1 free range lower limit analog val...	0
AD1 free range upper limit digital va...	0
AD1 free range lower limit digital va...	0

Unit display conversion:

This function is provided to facilitate customers to directly convert the collected analog quantity into the actual output unit of the required sensor. The user can manually configure the converted upper limit unit value and the corresponding lower limit unit value (if the free range is enabled, it is for the upper and lower limits after free conversion).

For example, set the unit as the pressure sensor unit Mp, and set 0~20mA to correspond to 0~10Mp, which can be set as follows:

Parameter	Value
AD1 unit display conversion upper limit	0
AD1 unit display conversion lower limit	0
AD2 unit display conversion	close
AD2 unit display conversion upper limit	0

Alarm upper/lower limit value:

When the digital operation value is in the preset range (the part shown by the thick line in the figure), the alarm is output. As shown in the following figure, this function is only for AD channel and can be configured through programming software.

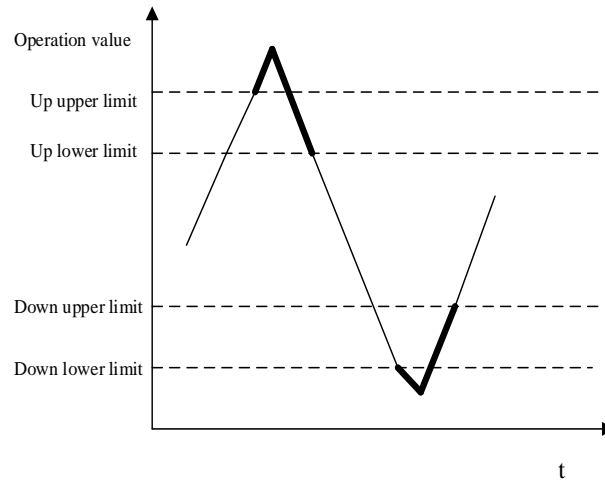

Parameter	Value
AD1 alarm upper and upper limit value	0
AD1 alarm upper and lower limit value	0
AD1 alarm lower and upper limit value	0
AD1 alarm lower and lower limit value	0

Traffic accumulation:

The formula for AD channel to realize traffic accumulation is:

$$Sum = CurrentFlow \times \frac{\Delta T}{T} \times rate + LastSum$$

In this formula,

Sum: Cumulative value this time,

CurrentFlow: Instantaneous flow, digital quantity collected by AD

ΔT : Accumulation cycle/ms, user input, range is 0~65535,

T: Unit conversion value, 1,10,100,1000,10000.

The cumulative cycle is input in ms and the range is 0~65535. The time conversion can convert the cumulative cycle into seconds, minutes and hours, and the parameters can be configured through the programming software of Xinje PLC.

If you need to clear the cumulative flow, you can turn on the Y1001n corresponding to channel n, and then clear the cumulative value.

4-5. Communication error registers

PLC register address		Description
SD500		Module No.#0~#15 correspond to #10000~#10015
SD501		Initialization result: 1 indicates successful initialization
SD502	Bit8~Bit15	-

	Bit0~Bit7	Abnormal code of communication with ontology
SD503	Bit8~Bit15	Module error type 2: communication timeout 3: Module model mismatch 129: ADC communication error
	Bit0~Bit7	-
SD504		Number of times
SD505	Bit8~Bit15	Channel 1 abnormal code 0: no error 17: channel short circuit 18: overrange 19: open circuit 22: parameter input error 23: calibration failed
	Bit0~Bit7	Abnormal channel 0~3

4-6. AD conversion diagram

The relationship between analog value and digital value is shown as the following diagram:

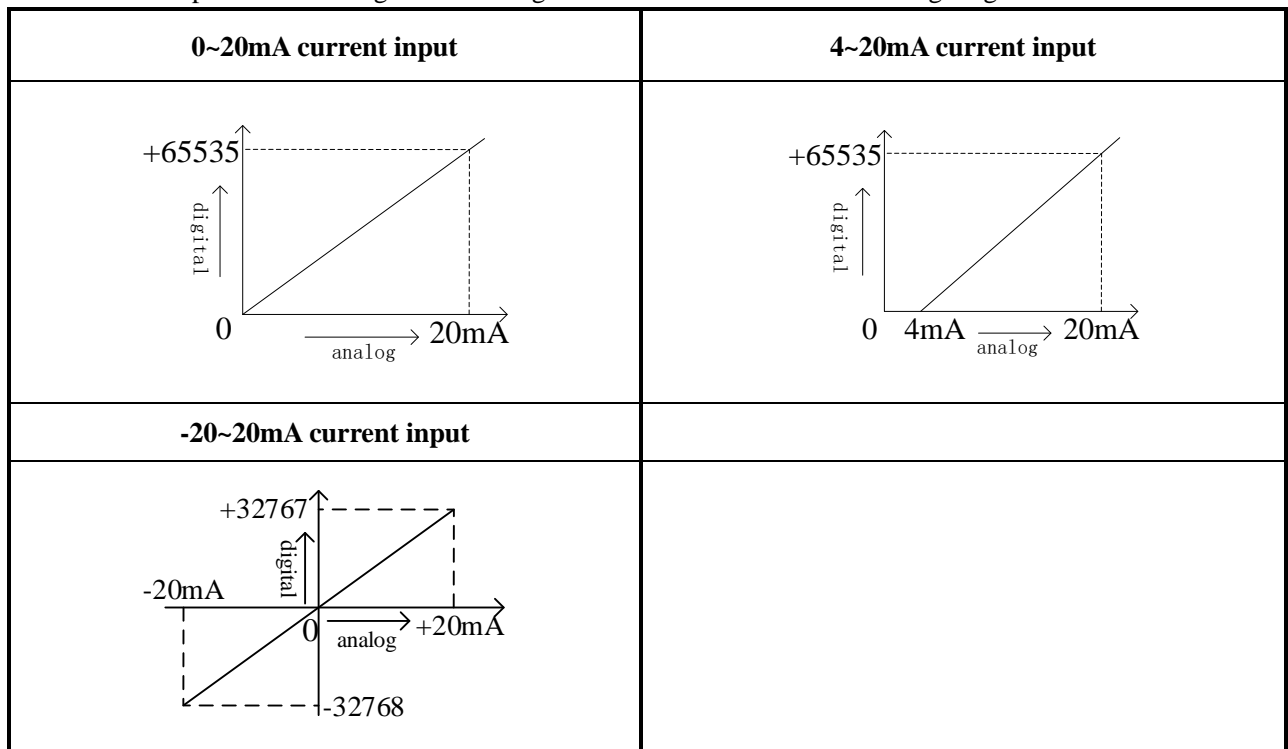

4-7. Program application

Real-time read the data of the 8 channels (module no.1)

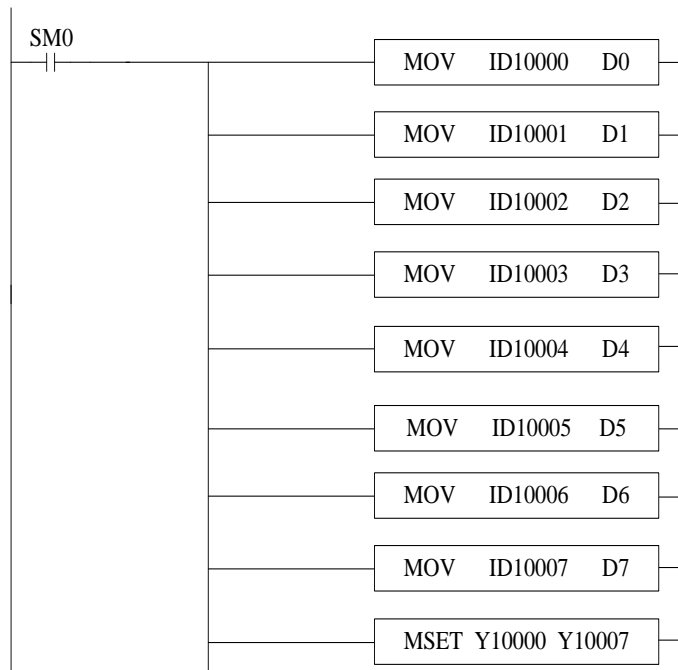

Explanation:

SM0 is always ON coil.

PLC is running. PLC keeps on writing channel 0 data to D0, channel 1 data to D1, channel 2 data to D2, channel 3 data to D3, channel 4 data to D4, channel 5 data to D5, channel 6 data to D6, channel 7 data to D7. Set ON all the channels enable bits.

5. Analog input module XG-E8AD-V-S

5-1. Specification

XG-E8AD-V-S transform the analog value (voltage input) to digital value and send to PLC registers.

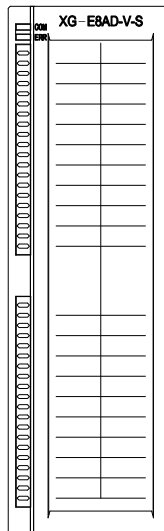

Features:

- 8-channel analog input: voltage input, 0~5V, 0~10V, -5~5V, -10~10V optional.
- 16-bit high precision analog input.
- As a special function module of XG series, up to 16 modules can be connected to the right side of the PLC.

Specifications:

Items	Voltage input
Analog input range	0~5V, 0~10V, -10~10V, -5~5V
Max input range	DC \pm 15V
Digital output range	16 bits binary data (0~65535 or -32768~32767)
Resolution	1/65535(16Bit)
Integrate Precision	\pm 1%
Conversion speed	2ms per channel
Analog power supply	DC24V \pm 10%,150mA
Installation	Directly install on the XG-EB guide rail
Dimension	130.0mm \times 40.0mm \times 133.4mm

5-2. Terminals and wiring

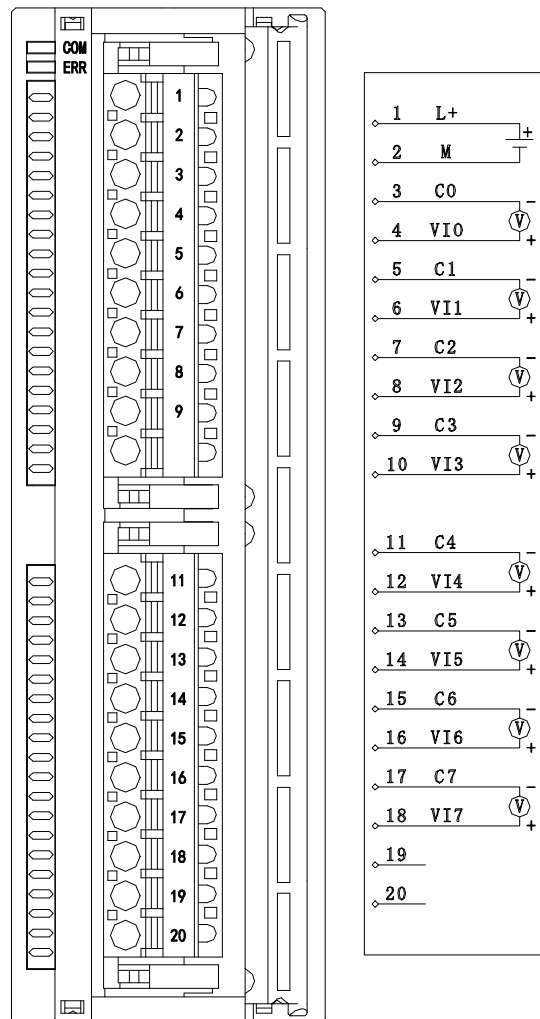

Channel	Terminal name	Signal name
CH0	VI0	voltage input
	C0	CH0 analog input common terminal
CH1	VI1	voltage input
	C1	CH1 analog input common terminal
CH2	VI2	voltage input
	C2	CH2 analog input common terminal
CH3	VI3	voltage input
	C3	CH3 analog input common terminal
CH4	VI4	voltage input
	C4	CH4 analog input common terminal
CH5	VI5	voltage input

	C5	CH5 analog input common terminal
CH6	VI6	voltage input
	C6	CH6 analog input common terminal
CH7	VI7	voltage input
	C7	CH7 analog input common terminal
-	L+	+24V power supply
	M	Common terminal of power supply

To avoid interference, please use shielded wire and ground the shielding layer at a single point.

XG series expansion modules are generally equipped with plug-in spring terminal connectors when leaving the factory. The length of wire sheath removal is required to be 1.5cm. When wiring, press the yellow spring switch with a small screwdriver, insert the wire into the corresponding jack, and release the spring switch.

5-3. I/O distribution

XG series analog expansion modules don't occupy I/O unit; the converted data is directly transferred to PLC register. Each channel address:

Note: each channel can only be used when the enable bit is turned on.

Parameter	Address				
	Channel	CH0	CH1	CH7
Module fault alarm	Module 1	X10000	X10001	X1000×	X10007
	Module 2	X10100	X10101	X1010×	X10107
	...	X10x00	X10x01	X10x0×	X10x07
	Module 16	X11700	X11701	X1170×	X11707
Upper limit alarm*	Module 1	X10010	X10011	X1001×	X10017
	Module 2	X10110	X10111	X1011×	X10117
	...	X10x10	X10x11	X10x1×	X10x17
	Module 16	X11710	X11711	X1171×	X11717
Lower limit alarm*	Module 1	X10020	X10021	X1002×	X10027
	Module 2	X10120	X10121	X1012×	X10127
	...	X10x20	X10x21	X10x2×	X10x27
	Module 16	X11720	X11721	X1172×	X11727
Enable bit	Module 1	Y10000	Y10001	Y1000×	Y10007
	Module 2	Y10100	Y10101	Y1010×	Y10107
	...	Y10x00	Y10x01	Y10x0×	Y10x07
	Module 16	Y11700	Y11701	Y1170×	Y11707
Traffic accumulative enable bit *	Module 1	Y10010	Y10011	Y1001×	Y10017
	Module 2	Y10010	Y10011	Y1001×	Y10017
	...	Y10x10	Y10x11	Y10x1×	Y10x17
	Module 16	Y11710	Y11711	Y1171×	Y11717

Output value (double word)	Module 1	ID10000	ID10002	ID1000×	ID10014
	Module 2	ID10100	ID10102	ID1010×	ID10114
	...	ID10x00	ID10x02	ID10x0×	ID10x14
	Module 16	ID11500	ID11502	ID1150×	ID11514
Original value display* (double word)	Module 1	ID10016	ID10018	ID100×	ID10030
	Module 2	ID10116	ID10118	ID101×	ID10130
	...	ID10x16	ID10x18	ID10x×	ID10x30
	Module 16	ID11516	ID11518	ID115×	ID11530
Traffic accumulation* (double word)	Module 1	ID10032	ID10034	ID100×	ID10046
	Module 2	ID10132	ID10134	ID101×	ID10146
	...	ID10x32	ID10x34	ID10x×	ID10x46
	Module 16	ID11532	ID11534	ID115×	ID11546

Note:

1. Since the register is displayed the signed value, the 16 bits unsigned number will be stored in double word form.
2. Forbid the unused channel to improve the I/O scanning speed.
3. If set off the enable bit of the channel, this channel will not accept the data. (the data display is 0).
4. Module fault alarm is used to alarm when the module has faults such as input out of range, wiring open circuit, short circuit, etc. When the above faults occur in the AD channel, its corresponding fault alarm X1001x will be set to on.
5. The parameters marked with * are advanced function parameters. Refer to "advanced configuration" in chapter 4-4 working mode setting for details.

5-4. Working mode

There are two ways to set the working mode:

1. XDPpro software
2. Flash registers of PLC

XDPpro software:

Open the XDPpro software, click configure/expansion module settings:

Set the model and channel parameters in the following window. Then click write to PLC.

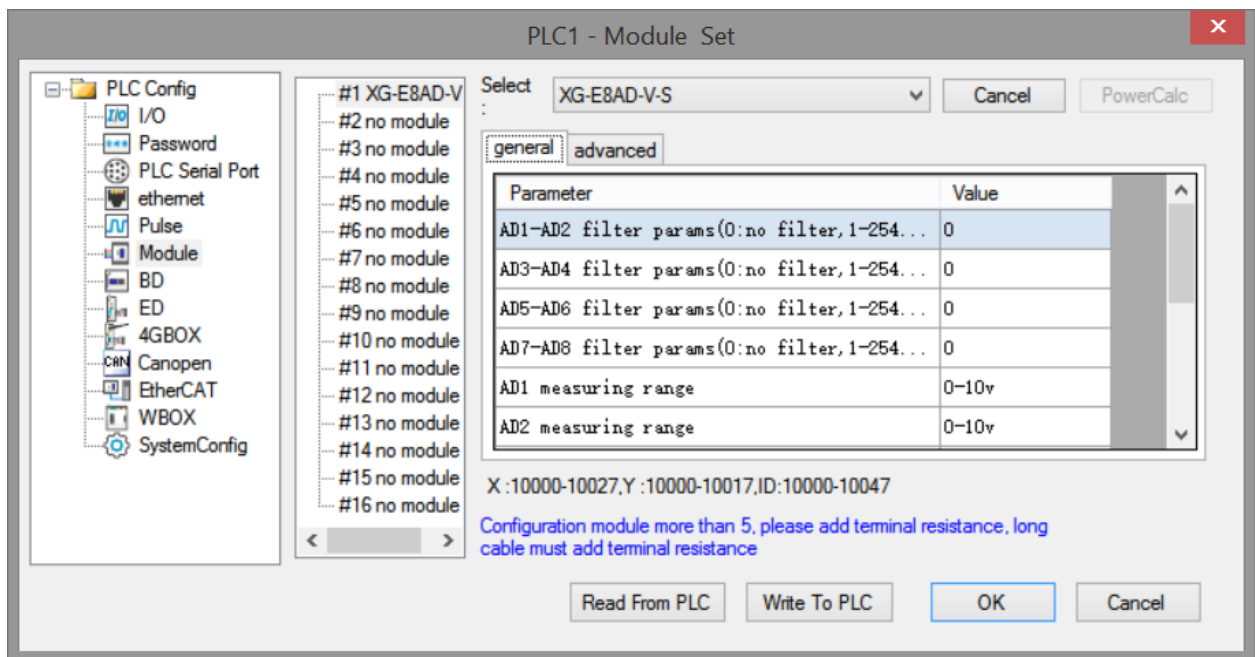

Please restart the PLC after setting.

Note:

1. The first-order low-pass filtering method uses this sampling value and the last filtering output value for weighting to get the effective filtering value. The filtering parameter is set to 0~254 by the user. By default, 0 means no filtering.
2. Please use XDPpro software v3.5.1 and up.

Flash registers:

The module is voltage input mode, the voltage range include 0~10V, 0~5V, -10~10V, -5~5V. Set the modes through SFD registers of PLC. See the following table:

Module no.	SFD address	Module no.	SFD address
#1	SFD350~SFD359	#9	SFD430~SFD439
#2	SFD360~SFD369	#10	SFD440~SFD449
#3	SFD370~SFD379	#11	SFD450~SFD459
#4	SFD380~SFD389	#12	SFD460~SFD469
#5	SFD390~SFD399	#13	SFD470~SFD479
#6	SFD400~SFD409	#14	SFD480~SFD489

#7	SFD410~SFD419	#15	SFD490~SFD499
#8	SFD420~SFD429	#16	SFD500~SFD509

Note: each SFD register can set 4 channels mode. Each register has 16 bits, every 4 bits set four channels mode.

SFD bit definition:

The configuration information occupies the first 20 bytes of the address, and the specific allocation of the address is shown in the following table:

	Bit7	Bit6	Bit5	Bit4	Bit3	Bit2	Bit1	Bit0
Byte0	AD channel 1 and channel 2 filter time							
Byte1	AD channel 3 and channel 4 filter time							
Byte2	AD channel 5 and channel 6 filter time							
Byte3	AD channel 7 and channel 8 filter time							
Byte4	AD2				AD1			
	-	000: 0~10V 001: 0~5V 100: -10~10V 101: -5~5V			-	000: 0~10V 001: 0~5V 100: -10~10V 101: -5~5V		
Byte5	AD4				AD3			
	-	000: 0~10V 001: 0~5V 100: -10~10V 101: -5~5V			-	000: 0~10V 001: 0~5V 100: -10~10V 101: -5~5V		
Byte6	AD6				AD5			
	-	000: 0~10V 001: 0~5V 100: -10~10V 101: -5~5V			-	000: 0~10V 001: 0~5V 100: -10~10V 101: -5~5V		
Byte7	AD8				AD7			
	-	000: 0~10V 001: 0~5V 100: -10~10V 101: -5~5V			-	000: 0~10V 001: 0~5V 100: -10~10V 101: -5~5V		
Byte8~byte19	-							

Advanced configuration:

Click advanced to do advanced setting for the module including AD calibration, unit display conversion, free range, alarm upper/lower limit, traffic accumulation.

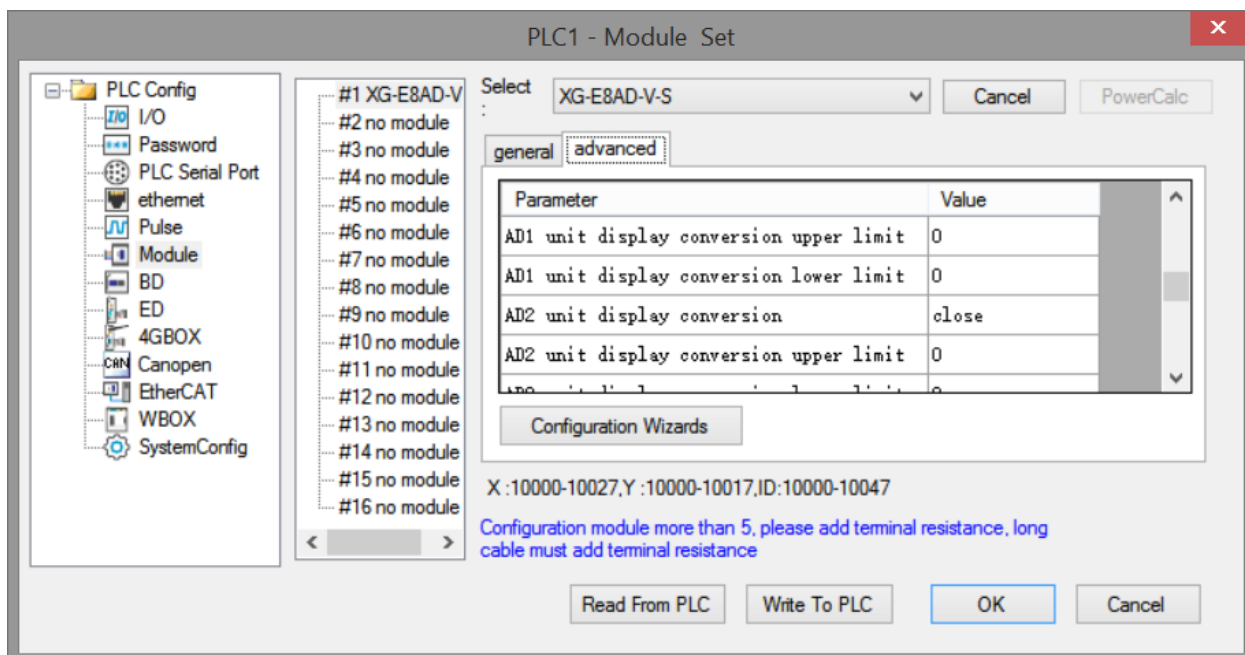

Advanced configuration information distribution:

Bit	AD calibration enable bit	Calibration voltage 1 analog value (uA)	Calibration voltage 1 digital value	Calibration voltage 2 analog value (uA)	Calibration voltage 2 digital value
Occupied bit description	1BIT/AD bit	INT16S	INT32S	INT16S	INT32S
Occupied word	1	1	2	1	2
Bit description	-	Unit conversion enable bit	Unit conversion upper limit	Unit conversion lower limit	-
Occupied bit description	-	1BIT/AD bit	INT32S	INT32S	-
Occupied word	-	1	2	2	-
Bit description	Up upper limit alarm value	Up lower limit alarm value	Down upper limit alarm value	Down lower limit alarm value	-
Occupied bit description	INT32S	INT32S	INT32S	INT32S	-
Occupied word	2	2	2	2	-
Bit	Free range	Free range upper	Free range	Free range	Free range

description	enable bit	limit analog value uA	upper limit digital value	lower limit analog value uA	upper limit digital value
Occupied bit description	1BIT/AD bit	INT16S	INT32S	INT16S	INT32S
Occupied word	1	1	2	1	2
Bit description	-	Traffic accumulation enable bit	Traffic accumulation cycle	Flow time coefficient	Scale factor
Occupied bit description	-	1BIT/AD bit	INT16U	INT16U	INT16U
Occupied word	-	1	1	1	1

The execution process of the above functions is:

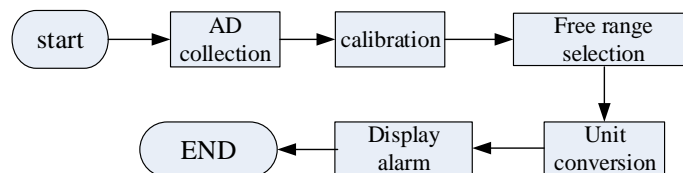

Calibration:

Since AD sampling will be offset after long-term use, the user can start calibration, input two measured values at this time (analog unit mV and digital quantity before calibration), and the expansion module will adjust the offset according to this situation.

User input: first open the calibration enable bit of the corresponding channel, and then input the first value analog quantity A1 and the corresponding digital quantity D1 at this time, and the second analog quantity A2 and the corresponding digital quantity D2 at this time, so as to carry out calibration.

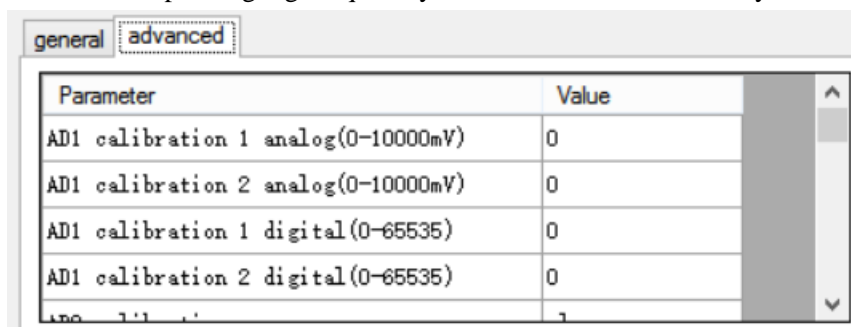

Free range:

Users can limit the sampling range (analog input, amplification of 1000 times integer data) through this mode. If the limit value is exceeded, the digital quantity will be automatically limited to the upper and lower limits.

The user turns on the channel free range enable bit, and then enters the analog value of the upper and lower limits of the range. The module automatically limits it to the corresponding digital value.

Assuming that the user sets the channel input range to 0~10V, the upper limit analog value of free range to

1000, and the lower limit analog value to 5000, it means that the limited sampling range is 1~5V. If the input current exceeds 5V, the corresponding digital quantity display is still 32767.

Parameter	Value
AD1 free range upper limit analog val...	0
AD1 free range lower limit analog val...	0
AD1 free range upper limit digital va...	0
AD1 free range lower limit digital va...	0

Unit display conversion:

This function is provided to facilitate customers to directly convert the collected analog quantity into the actual output unit of the required sensor. The user can manually configure the converted upper limit unit value and the corresponding lower limit unit value (if the free range is enabled, it is for the upper and lower limits after free conversion).

For example, set the unit as the pressure sensor unit Mp, and set 0~5V to correspond to 0~10Mp, which can be set as follows:

Parameter	Value
AD1 unit display conversion upper limit	0
AD1 unit display conversion lower limit	10
AD2 unit display conversion	close
AD2 unit display conversion upper limit	0

Alarm upper/lower limit value:

When the digital operation value is in the preset range (the part shown by the thick line in the figure), the alarm is output. As shown in the following figure, this function is only for AD channel and can be configured through programming software.

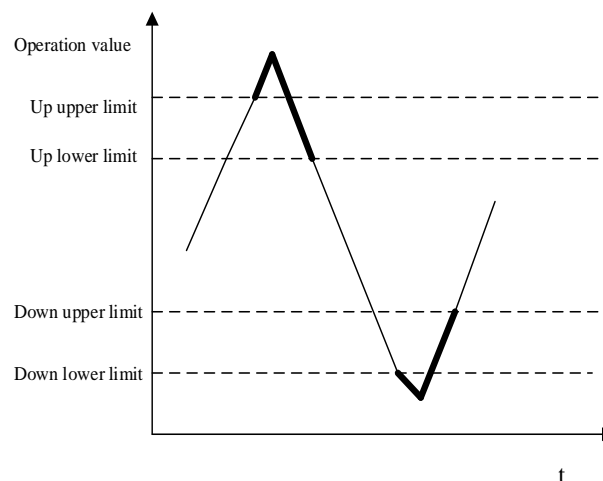

general		advanced
Parameter	Value	
AD1 alarm upper and upper limit value	0	
AD1 alarm upper and lower limit value	0	
AD1 alarm lower and upper limit value	0	
AD1 alarm lower and lower limit value	0	

Traffic accumulation:

The formula for AD channel to realize traffic accumulation is:

$$Sum = CurrentFlow \times \frac{\Delta T}{T} \times rate + LastSum$$

In this formula,

Sum: Cumulative value this time,

CurrentFlow: Instantaneous flow, digital quantity collected by AD

ΔT : Accumulation cycle/ms, user input, range is 0~65535,

T: Unit conversion value, 1,10,100,1000,10000.

The cumulative cycle is input in ms and the range is 0~65535. The time conversion can convert the cumulative cycle into seconds, minutes and hours, and the parameters can be configured through the programming software of Xinje PLC.

If you need to clear the cumulative flow, you can turn on the Y1001n corresponding to channel n, and then clear the cumulative value.

5-5. Communication error registers

PLC register address		Description
SD500		Module No.#0~#15 correspond to #10000~#10015
SD501		Initialization result: 1 indicates successful initialization
SD502	Bit8~Bit15	-
	Bit0~Bit7	Abnormal code of communication with ontology
SD503	Bit8~Bit15	Module error type 2: communication timeout 3: Module model mismatch 129: ADC communication error
	Bit0~Bit7	-
SD504		Number of times
SD505	Bit8~Bit15	Channel 1 abnormal code 0: no error 17: channel short circuit 18: overrange 19: open circuit

		22: parameter input error 23: calibration failed
	Bit0~Bit7	Abnormal channel 0~3

5-6. AD conversion diagram

The relationship between analog value and digital value is shown as the following diagram:

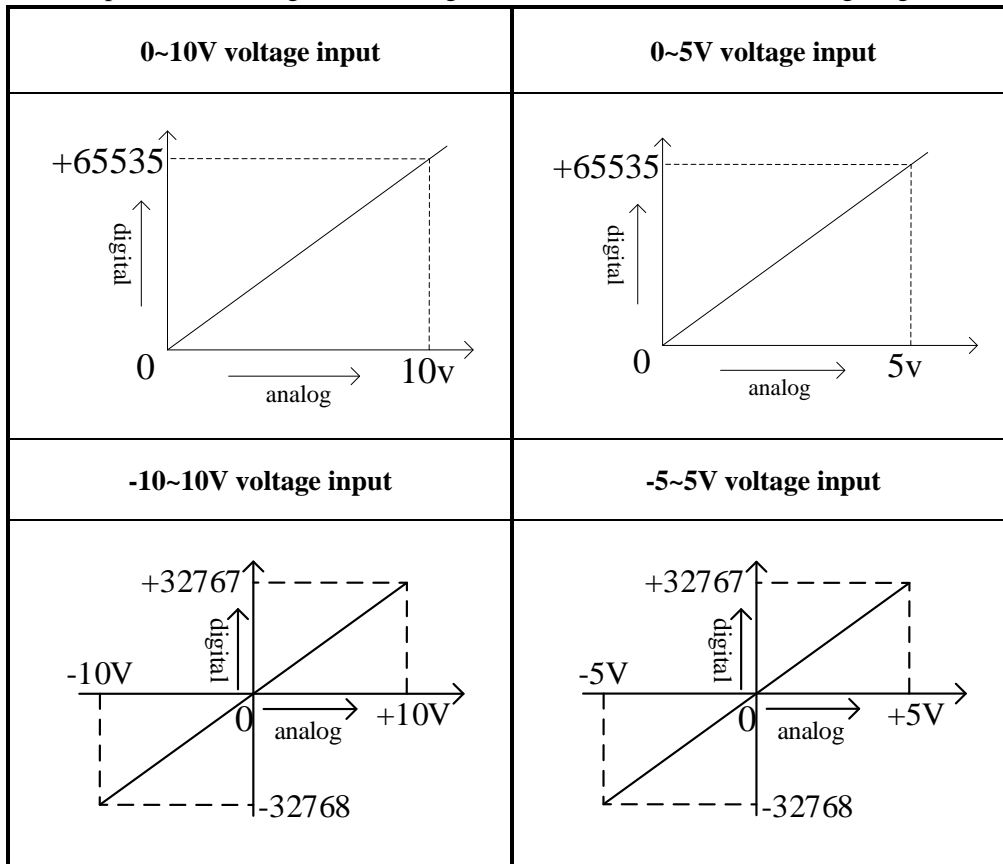

5-7. Program application

Real-time read the data of the 8 channels (module no.1)

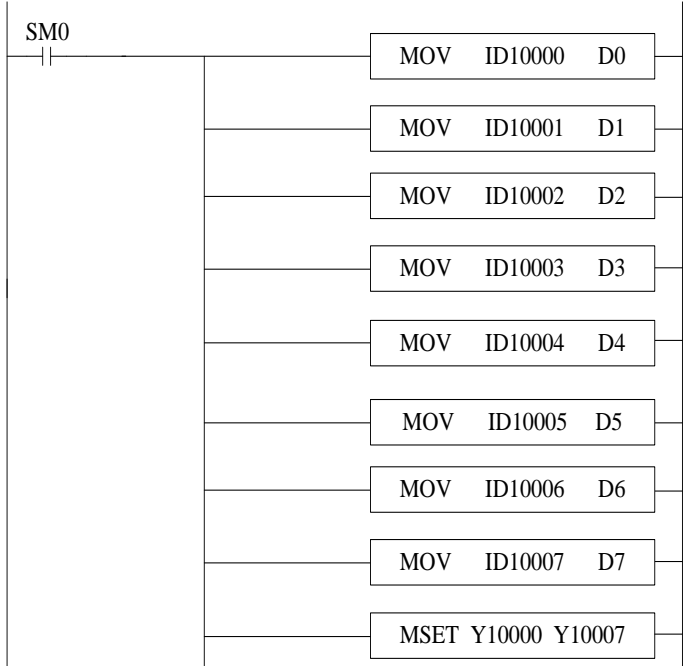

Explanation:

SM0 is always ON coil.

PLC is running. PLC keeps on writing channel 0 data to D0, channel 1 data to D1, channel 2 data to D2, channel 3 data to D3, channel 4 data to D4, channel 5 data to D5, channel 6 data to D6, channel 7 data to D7. Set ON all the channels enable bits.

6. Analog output module XG-E4DA-S

6-1. Specifications

XG-E4DA-S module transforms 4 channels digital value to analog value and send the data to PLC.

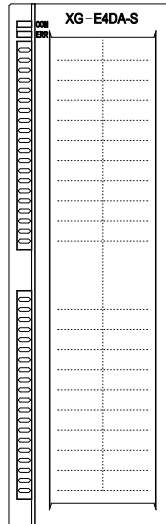

Features:

- 4-channel analog output: voltage output (0~5V, 0~10V, -10~10V, -5~5V optional) or current output (0~20mA, 4~20mA optional).
- 16-bit high precision analog output.
- As a special function module of XG series, up to 16 modules can be connected on the right side of the PLC.

Specifications:

Items	Voltage output	Current output
Analog output	0~5V, 0~10V, -5~5V, -10~10V (external load resistor 2K Ω ~1M Ω)	0~20mA, 4~20mA (external load resistor is less than 500 Ω)
Digital input	16 bits binary value (0~65535 or -32768~32767)	
Resolution	1/65535 (16 bit)	
General precision	$\pm 1\%$	
Conversion speed	2ms per channel	
Power supply for analog using	DC24V $\pm 10\%$, 150mA	
Installation	Directly install on XG-EB guide rail	
Dimension	130.0mm \times 40.0mm \times 133.4mm	

6-2. Terminals and wiring

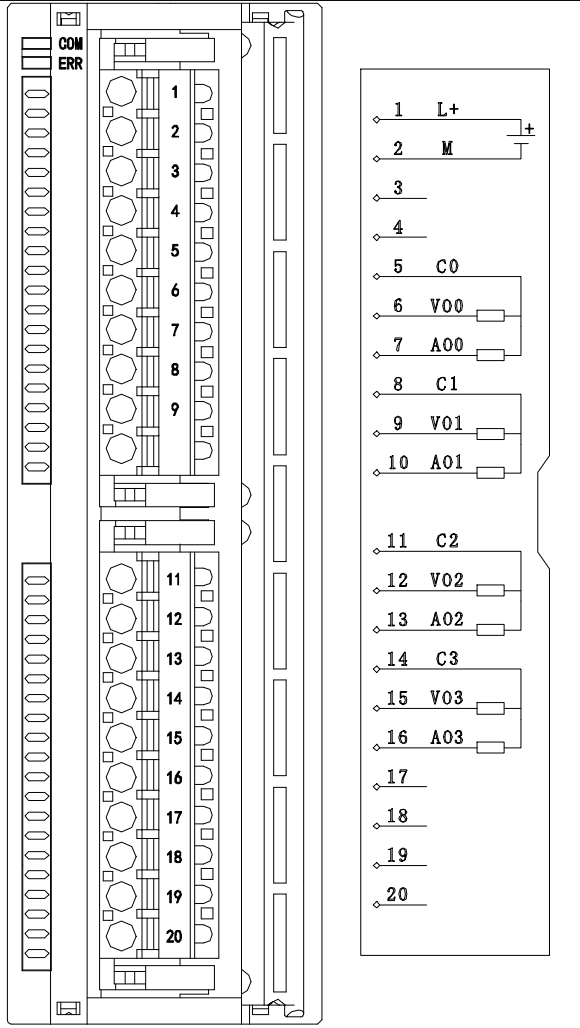

Channel	Terminal name	Signal name
CH0	A00	Current output
	VO0	Voltage output
	C0	CH0 common terminal
CH1	A01	Current output
	VO1	Voltage output
	C1	CH1 common terminal
CH2	A02	Current output
	VO2	Voltage output
	C2	CH2 common terminal
CH3	A03	Current output
	VO3	Voltage output
	C3	CH3 common terminal

	L+	+24V power supply
-	M	Common terminal of power supply

To avoid interference, please use shielded wire and ground the shielding layer at a single point.

XG series expansion modules are generally equipped with plug-in spring terminal connectors when leaving the factory. The length of wire sheath removal is required to be 1.5cm. When wiring, press the yellow spring switch with a small screwdriver, insert the wire into the corresponding jack, and release the spring switch.

The wiring of XG-E4DA-S current output side is shown in the following figure:

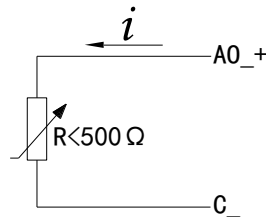

6-3. I/O address assignment

XG series analog modules don't occupy I/O units; the converted value is sent to PLC register directly.

The PLC registers are shown as the following:

Note: each channel can only be used when the enable bit is turned on.

Expansion module no.1

Channel	DA signal	Channel enable bit (set on this bit to use this channel)
0CH	QD10000	Y10000
1CH	QD10001	Y10001
2CH	QD10002	Y10002
3CH	QD10003	Y10003

Expansion module no.2

Channel	DA signal	Channel enable bit (set on this bit to use this channel)
0CH	QD10100	Y10100
1CH	QD10101	Y10101
2CH	QD10102	Y10102
3CH	QD10103	Y10103

Expansion module no.3

Channel	DA signal	Channel enable bit (set on this bit to use this channel)
0CH	QD10200	Y10200
1CH	QD10201	Y10201
2CH	QD10202	Y10202
3CH	QD10203	Y10203

Expansion module no.4

Channel	DA signal	Channel enable bit (set on this bit to use this channel)
0CH	QD10300	Y10300
1CH	QD10301	Y10301
2CH	QD10302	Y10302
3CH	QD10303	Y10303

Expansion module no.5

Channel	DA signal	Channel enable bit (set on this bit to use this channel)
0CH	QD10400	Y10400
1CH	QD10401	Y10401
2CH	QD10402	Y10402
3CH	QD10403	Y10403

Expansion module no.6

Channel	DA signal	Channel enable bit (set on this bit to use this channel)
0CH	QD10500	Y10500
1CH	QD10501	Y10501
2CH	QD10502	Y10502
3CH	QD10503	Y10503

Expansion module no.7

Channel	DA signal	Channel enable bit (set on this bit to use this channel)
0CH	QD10600	Y10600
1CH	QD10601	Y10601
2CH	QD10602	Y10602

3CH	QD10603	Y10603
-----	---------	--------

Expansion module no.8

Channel	DA signal	Channel enable bit (set on this bit to use this channel)
0CH	QD10700	Y10700
1CH	QD10701	Y10701
2CH	QD10702	Y10702
3CH	QD10703	Y10703

Expansion module no.9

Channel	DA signal	Channel enable bit (set on this bit to use this channel)
0CH	QD10800	Y11000
1CH	QD10801	Y11001
2CH	QD10802	Y11002
3CH	QD10803	Y11003

Expansion module no.10

Channel	DA signal	Channel enable bit (set on this bit to use this channel)
0CH	QD10900	Y11100
1CH	QD10901	Y11101
2CH	QD10902	Y11102
3CH	QD10903	Y11103

Expansion module no.11

Channel	DA signal	Channel enable bit (set on this bit to use this channel)
0CH	QD11000	Y11200
1CH	QD11001	Y11201
2CH	QD11002	Y11202
3CH	QD11003	Y11203

Expansion module no.12

Channel	DA signal	Channel enable bit (set on this bit to use this channel)
0CH	QD11100	Y11300

1CH	QD11101	Y11301
2CH	QD11102	Y11302
3CH	QD11103	Y11303

Expansion module no.13

Channel	DA signal	Channel enable bit (set on this bit to use this channel)
0CH	QD11200	Y11400
1CH	QD11201	Y11401
2CH	QD11202	Y11402
3CH	QD11203	Y11403

Expansion module no.14

Channel	DA signal	Channel enable bit (set on this bit to use this channel)
0CH	QD11300	Y11500
1CH	QD11301	Y11501
2CH	QD11302	Y11502
3CH	QD11303	Y11503

Expansion module no.15

Channel	DA signal	Channel enable bit (set on this bit to use this channel)
0CH	QD11400	Y11600
1CH	QD11401	Y11601
2CH	QD11402	Y11602
3CH	QD11403	Y11603

Expansion module no.16

Channel	DA signal	Channel enable bit (set on this bit to use this channel)
0CH	QD11500	Y11700
1CH	QD11501	Y11701
2CH	QD11502	Y11702
3CH	QD11503	Y11703

Note:

1. Forbid the unused channel to improve the I/O scanning speed.

2. If set off the enable bit of the output channel, this channel will keep the present value.
3. Since the register is displayed as a signed value, the 16 bits unsigned number will be stored in double word form.

6-4. Working mode

There are two ways to set the working mode:

1. XDPpro software
2. Flash registers of PLC

XDPpro software:

Open the XDPpro software, click configure/expansion module settings:

Set the model and channel parameters in the following window. Then click write to PLC.

Please restart the PLC after setting.

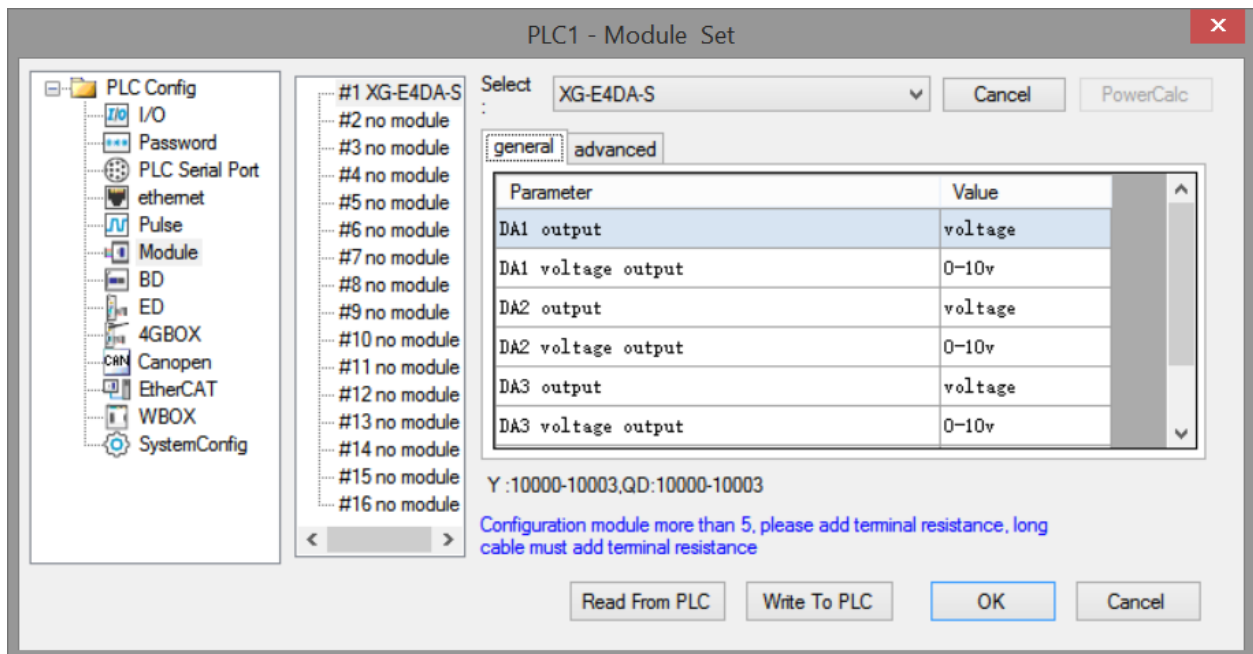

Flash registers:

The module output has voltage 0~5V, 0~10V, -5~5V, -10~10V, current 0 ~ 20mA, 4 ~ 20mA, set the modes through the PLC FLASH registers SFD.

Module no.	SFD address	Module no.	SFD address
#1	SFD350~SFD359	#9	SFD430~SFD439
#2	SFD360~SFD369	#10	SFD440~SFD449

#3	SFD370~SFD379	#11	SFD450~SFD459
#4	SFD380~SFD389	#12	SFD460~SFD469
#5	SFD390~SFD399	#13	SFD470~SFD479
#6	SFD400~SFD409	#14	SFD480~SFD489
#7	SFD410~SFD419	#15	SFD490~SFD499
#8	SFD420~SFD429	#16	SFD500~SFD509

SFD bit definition:

Expansion module no.1:

	Bit7	Bit6	Bit5	Bit4	Bit3	Bit2	Bit1	Bit0
Byte0	DA2				DA1			
	-	Voltage 000: 0~10V 001: 0~5V 100: -10~10V 101: -5~5V			-	Voltage 000: 0~10V 001: 0~5V 100: -10~10V 101: -5~5V		
		Current 010: 0~20mA 011: 4~20mA				Current 010: 0~20mA 011: 4~20mA		
	Bit7	Bit6	Bit5	Bit4	Bit3	Bit2	Bit1	Bit0
Byte1	DA4				DA3			
	-	Voltage 000: 0~10V 001: 0~5V 100: -10~10V 101: -5~5V			-	Voltage 000: 0~10V 001: 0~5V 100: -10~10V 101: -5~5V		
		Current 010: 0~20mA 011: 4~20mA				Current 010: 0~20mA 011: 4~20mA		
Byte2~Byte19	-							

Advanced configuration:

Click advanced to do advanced setting for the module including calibration, unit display conversion.

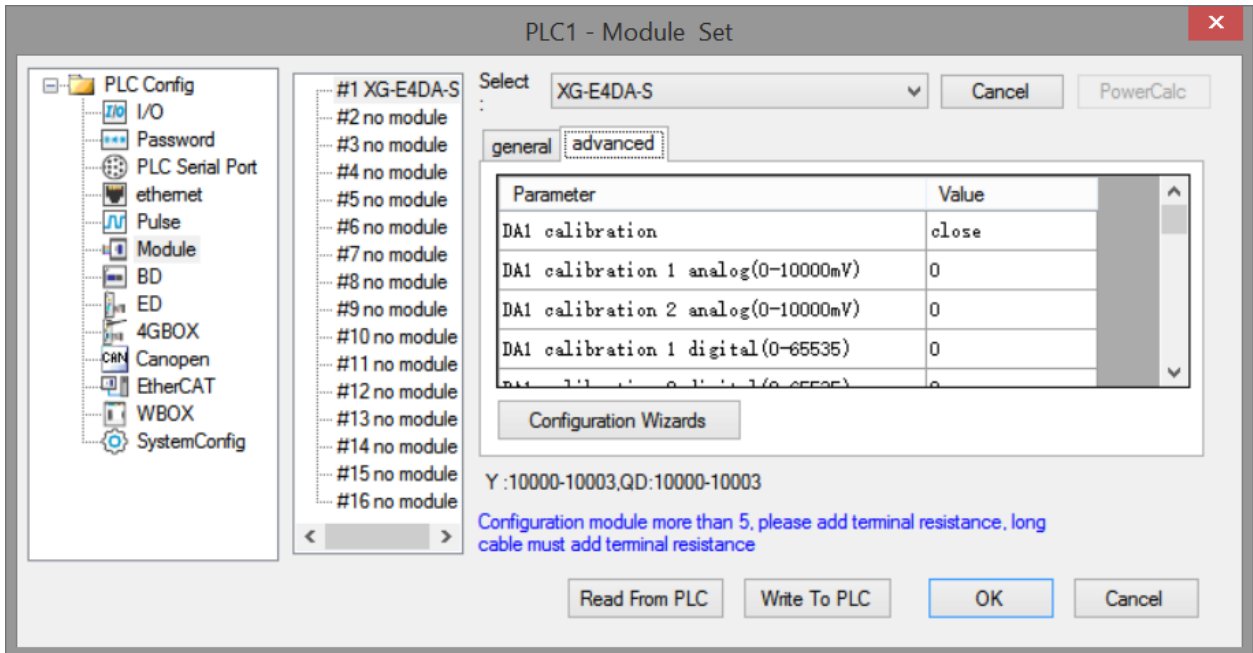

Calibration:

Since AD sampling will be offset after long-term use, the user can start calibration, input two measured values at this time (analog unit mV and digital quantity before calibration), and the expansion module will adjust the offset according to this situation.

User input: first open the calibration enable bit of the corresponding channel, and then input the first value analog quantity A1 and the corresponding digital quantity D1 at this time, and the second analog quantity A2 and the corresponding digital quantity D2 at this time, so as to carry out calibration.

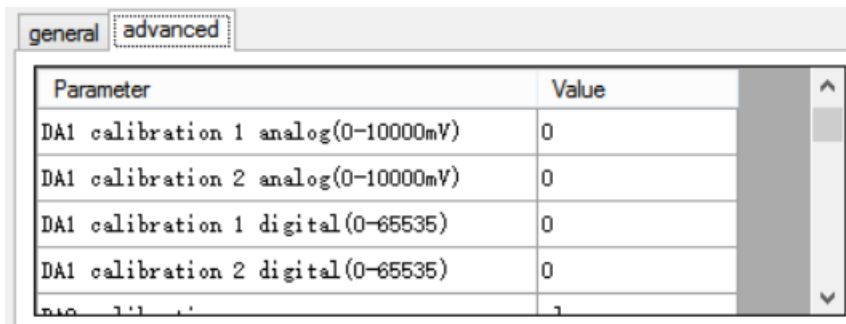

Unit display conversion:

This function is provided to facilitate customers to directly convert the collected analog quantity into the actual output unit of the required sensor. The user can manually configure the converted upper limit unit value and the corresponding lower limit unit value (if the free range is enabled, it is for the upper and lower limits after free conversion).

For example, set the unit as the pressure sensor unit Mp, and set 0~20mA to correspond to 0~10Mp, which can be set as follows:

general		advanced
Parameter	Value	
DA1 unit display conversion upper limit	0	
DA1 unit display conversion lower limit	0	
DA2 unit display conversion	close	
DA2 unit display conversion upper limit	0	

6-5. Communication error registers

PLC register address		Description
SD500		Module No.#0~#15 correspond to #10000~#10015
SD501		Initialization result: 1 indicates successful initialization
SD502	Bit8~Bit15	-
	Bit0~Bit7	Abnormal code of communication with ontology
SD503	Bit8~Bit15	Module error type 2: communication timeout 3: Module model mismatch 129: ADC communication error
	Bit0~Bit7	-
SD504		Number of times
SD505	Bit8~Bit15	Channel 1 abnormal code 0: no error 17: channel short circuit 18: parameter input error
	Bit0~Bit7	Abnormal channel 0~3

6-6. DA conversion diagram

The relationship between digital input value and analog output value is shown as below:

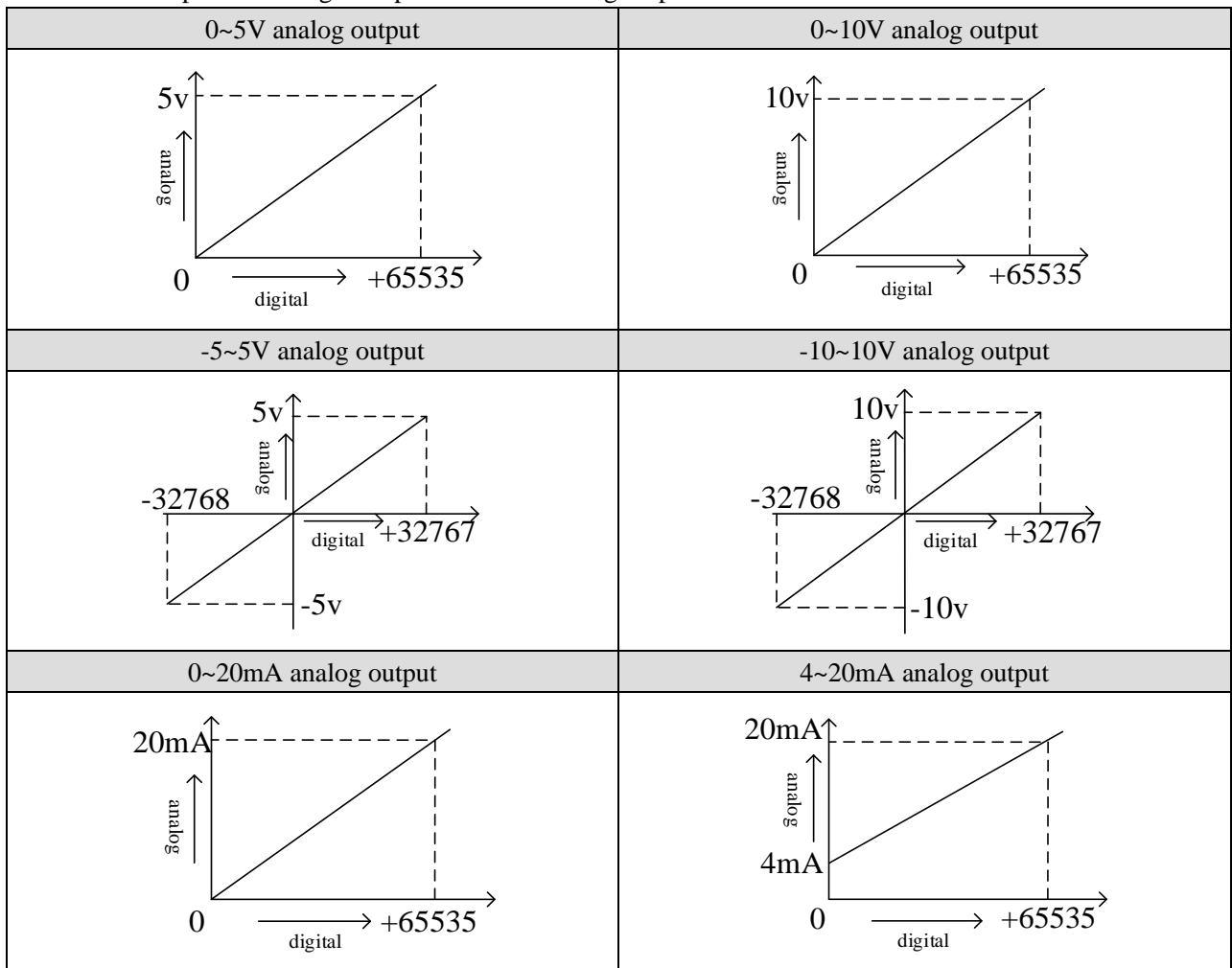

Note: when the input data exceeds K65535, the output analog data of D/A conversion remains unchanged at 5V, 10V or 20mA.

6-7. Programming

For example, it is necessary to output a 0V~10V voltage signal to the frequency converter.

Analysis: the set digital quantity range 0~65535 in the expansion module register QD corresponds to the voltage output signal 0V~10V, $10V/65535=0.000152588$, which indicates how many voltage values are output for each set digital quantity in the expansion module register QD. For example, now you need to output 3V voltage value, $3V/0.000152588=19660$, and send the calculated digital quantity value to the corresponding QD register.

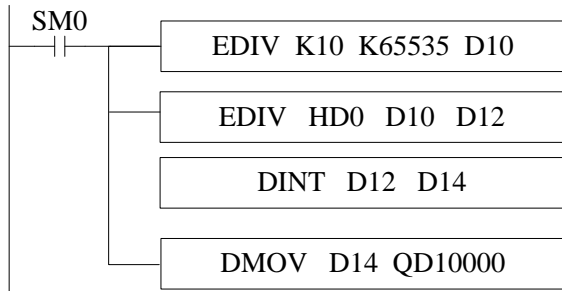

Explanation:

In this example, the first channel is used, so please set the channel 1 enable bit Y10000 to ON.

SM0 is a normally on coil, which is always on during PLC operation.

HD0 is used to specify the amount of output voltage.

When the PLC starts to run, the analog output first calculates the voltage value corresponding to each digital 1 of the digital quantity collected by the expansion module, and then divides the set target voltage value by the voltage value corresponding to each digital 1 of the digital quantity collected by the expansion module to obtain the digital quantity (floating point number) that needs to be set. Since the QD10000 register can only store integers, it is necessary to convert the obtained floating point number into integers and send them to QD10000. In addition, QD10000 is a double-word register, and the instructions involved in the program must also use 32-bit instruction format.

Note: please use floating-point operation for calculation, otherwise the calculation accuracy will be affected or even unable to be calculated!

7. Pt100 temperature control module XG-E8PT3-P

7-1. Specification

XG-E8PT3-P temperature PID control module processes 8-point PT100 temperature signals and transmits them to PLC main unit.

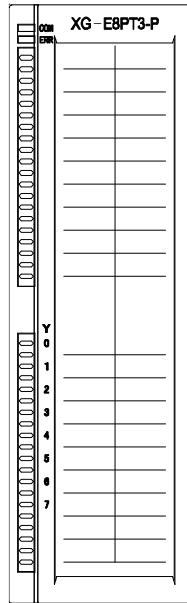

Features:

- Platinum thermal resistance input, Pt100
- 8 channels input, 8 channels output, 8 groups of PID parameters, auto-tune function
- 1mA constant current output, will not be affected by the exterior environment
- Resolution is 0.1°C
- XG series PLC can connect up to 16 expansion modules.

Specifications:

Item	Content
Analog input signal	Pt100 platinum thermal-resistance
Temperature measurement range	-100°C ~ 500°C
Digital output bound	-1000~5000, 16 bits with sign bit, binary
Control precision	±0.5°C
Resolution	0.1°C
Integrate precision	± 1% (relative max value)
Conversion speed	150ms /8 channels
Analog power	DC24V±10%, 50mA
Installation format	Directly install on XG-EB guide rail

Dimension	130.0mm×40.0mm×133.4mm
-----------	------------------------

Note:

1. When there is no signal input, the channel data is the maximum value of the digital output range.
2. Connect to Pt100 platinum thermal resistance according to actual requirements

7-2. Terminals and wiring

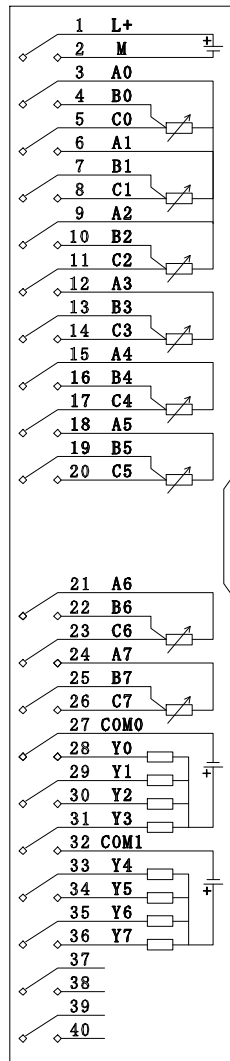

Channel	Terminal	Signal	Channel	Terminal	Signal
CH0	A0	0CH thermal resistance input terminal	CH1	A1	1CH thermal resistance input terminal
	B0	0CH thermal resistance input common terminal		B1	1CH thermal resistance input common terminal
	C0	0CH thermal resistance input common terminal		C1	1CH thermal resistance input common terminal

CH2	A2	2CH thermal resistance input terminal	CH3	A3	3CH thermal resistance input terminal
	B2	2CH thermal resistance input common terminal		B3	3CH thermal resistance input common terminal
	C2	2CH thermal resistance input common terminal		C3	3CH thermal resistance input common terminal
CH4	A4	4CH thermal resistance input terminal	CH5	A5	5CH thermal resistance input terminal
	B4	4CH thermal resistance input common terminal		B5	5CH thermal resistance input common terminal
	C4	4CH thermal resistance input common terminal		C5	5CH thermal resistance input common terminal
CH6	A6	6CH thermal resistance input terminal	CH7	A7	7CH thermal resistance input terminal
	B6	6CH thermal resistance input common terminal		B7	7CH thermal resistance input common terminal
	C6	6CH thermal resistance input common terminal		C7	7CH thermal resistance input common terminal
Y0~Y7		PID output channel 0~7			
COM0~COM1		PID output common terminal			
-	L+	+24V power supply input			
	M	Power supply common terminal			

In order to avoid interference during external connection, please use shielded wire and single point ground the shielded layer.

XG series expansion modules are generally equipped with plug-in spring terminal connectors when leaving the factory. The length of wire sheath removal is required to be 1.5cm. When wiring, press the yellow spring switch with a small screwdriver, insert the wire into the corresponding jack, and release the spring switch.

Output connection:

- Output terminals: transistor output terminal, please choose DC 5V~30V power supply.
- Circuit insulation: PLC interior circuit and output transistor is optical insulation. Each public module is also separated.
- Response time: the time is less than 0.2ms from PLC driving (or cut) optical coupling device to transistor ON/OFF.
- Output current: each point current is 50mA to avoid over-heat.
- Open circuit leakage current: below 0.1mA

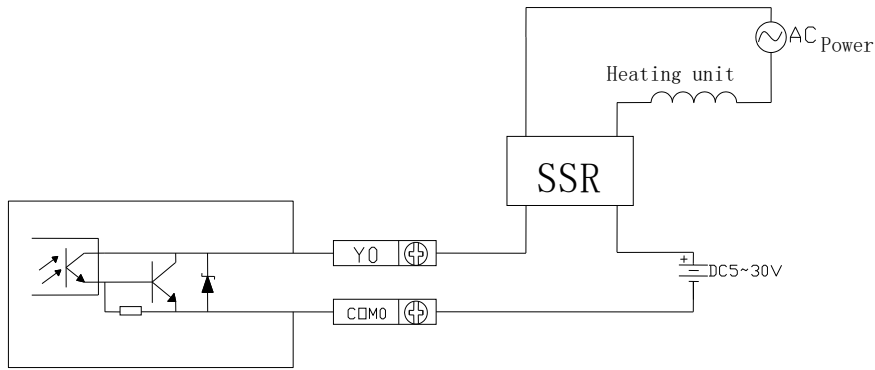

PT100 input characteristic curve:

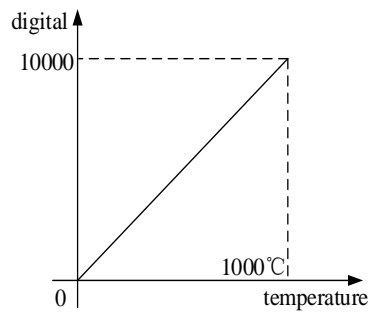

7-3. I/O address assignment

XG series analog modules don't occupy I/O units; the converted data is directly transferred into PLC register. The PLC registers are shown as the following:

Parameter	Explanation					
	Channel	CH0	CH1	CH2	...	CH7
Temperature display	Module 1	ID10000	ID10001	ID10002	...	ID10007
	Module 2	ID10100	ID10101	ID10102	...	ID10107
	...	ID10x00	ID10x01	ID10x02	...	ID10x07
	Module 16	ID11500	ID11501	ID11502	...	ID11507
PID enable bit	Module 1	Y10000	Y10001	Y10002	...	Y10007
	Module 2	Y10100	Y10101	Y10102	...	Y10107
	...	Y10x00	Y10x01	Y10x02	...	Y10x07
	Module 16	Y11700	Y11701	Y11702	...	Y11707
PID output (return to PLC X input)	Module 1	X10000	X10001	X10002	...	X10007
	Module 2	X10100	X10101	X10102	...	X10107
	...	X10x00	X10x01	X10x02	...	X10x07
	Module 16	X11700	X11701	X11702	...	X11707
Open circuit detection (0: connected, 1: disconnected)	Module 1	X10010	X10011	X10012	...	X10017
	Module 2	X10110	X10111	X10112	...	X10117
	...	X10x10	X10x11	X10x12	...	X10x17

	Module 16	X11710	X11711	X11712	...	X11717
Auto-tune error (0: normal, 1: auto-tune error)	Module 1	X10020	X10021	X10022	...	X10027
	Module 2	X10120	X10121	X10122	...	X10127
	...	X10x20	X10x21	X10x22	...	X10x27
	Module 16	X11720	X11721	X11722	...	X11727
Temperature upper limit alarm*	Module 1	X10030	X10031	X10032	...	X10037
	Module 2	X10130	X10131	X10132	...	X10137
	...	X10x30	X10x31	X10x32	...	X10x37
	Module 16	X11730	X11731	X11732	...	X11737
Temperature lower limit alarm*	Module 1	X10040	X10041	X10042	...	X10047
	Module 2	X10140	X10141	X10142	...	X10147
	...	X10x40	X10x41	X10x42	...	X10x47
	Module 16	X11740	X11741	X11742	...	X11747
Offset upper limit alarm*	Module 1	X10050	X10051	X10052	...	X10057
	Module 2	X10150	X10151	X10152	...	X10157
	...	X10x50	X10x51	X10x52	...	X10x57
	Module 16	X11750	X11751	X11752	...	X11757
Offset lower limit alarm*	Module 1	X10060	X10061	X10062	...	X10067
	Module 2	X10160	X10161	X10162	...	X10167
	...	X10x60	X10x61	X10x62	...	X10x67
	Module 16	X11760	X11761	X11762	...	X11767
Auto-tune PID control	The auto-tuning trigger signal, enter the auto-tuning stage when it is set to 1. After the auto-tuning is completed, the PID parameter is refreshed and the bit is automatically cleared to zero. The stage can be judged according to its status.					
PID output function (digital value)	Digital value output range is 0~4095					
PID parameters	The optimal parameters can be obtained by PID auto-tuning. You can also set parameters by yourself					
PID calculation range (unit 0.1°C)	This function can set the temperature range of PID calculation. For example, set T_{diff} , target temperature T_{target} , then PID calculation range is $T_{target}-T_{diff} \leq T \leq T_{target} + T_{diff}$, when $T < T_{target}-T_{diff}$, the output is the max, when $T > T_{target} + T_{diff}$, output is 0.					
Temperature offset δ (unit 0.1°C)	Actual temperature = (sampling temperature+temperature offset δ) /10. The value is calculated by the module itself according to the temperature calibration value, and the user does not need to input.					
Setting temperature (unit 0.1°C)	Target temperature of control system. Range is 0~1000°C, precision 0.1°C.					
Temperature control cycle (unit 0.1s)	During PID control, the output terminal will heat according to the duty ratio calculated by the PID output value within the cycle time, which is the temperature control cycle. The adjustment range of the temperature control cycle is 0.5s ~ 200s, the minimum accuracy is 0.1s, and the write value is ten times of the actual temperature control cycle. For example, if 5 is written, the actual temperature control cycle is 0.5s.					
Temperature calibration	If it is considered that there is a deviation between the actual temperature and the					

(unit 0.1°C)	<p>module acquisition temperature, the known temperature can be written into the corresponding register. After writing, the module calculates the difference between the collected temperature and the actual temperature according to the value and saves it.</p> <p>Temperature offset δ=actual input temperature -sampling temperature (Note: this value should not be written arbitrarily, otherwise it will cause display temperature error.)</p>
Auto tune output range	<p>The input amount unit of the auto-tuning is % and the input 100 indicates the full-scale output (if no output is found during use, the value can be read to see if it is 0).</p>

Note:

- (1) When Y of the PID enable bit is 0, the PID control is turned off, and when Y is 1, the PID control is turned on.
- (2) Open circuit detection: when the channel is not connected to the sensor, the corresponding value of X1001x is on, and the digital value of temperature display is 5000.
- (3) Auto tuning failure: when the user starts the auto-tuning, it will judge whether the system's current setting is successful according to the set parameters. If not, set the corresponding X1002x.
- (4) Those marked with * are advanced function settings. Refer to "advanced configuration" in chapter 7-4 for details of parameters.

7-4. FROM/TO instruction

The reading and writing of XG-E8PT3-P module needs to be completed through the FROM/TO instruction in the sequential function block, as shown in the figure below:

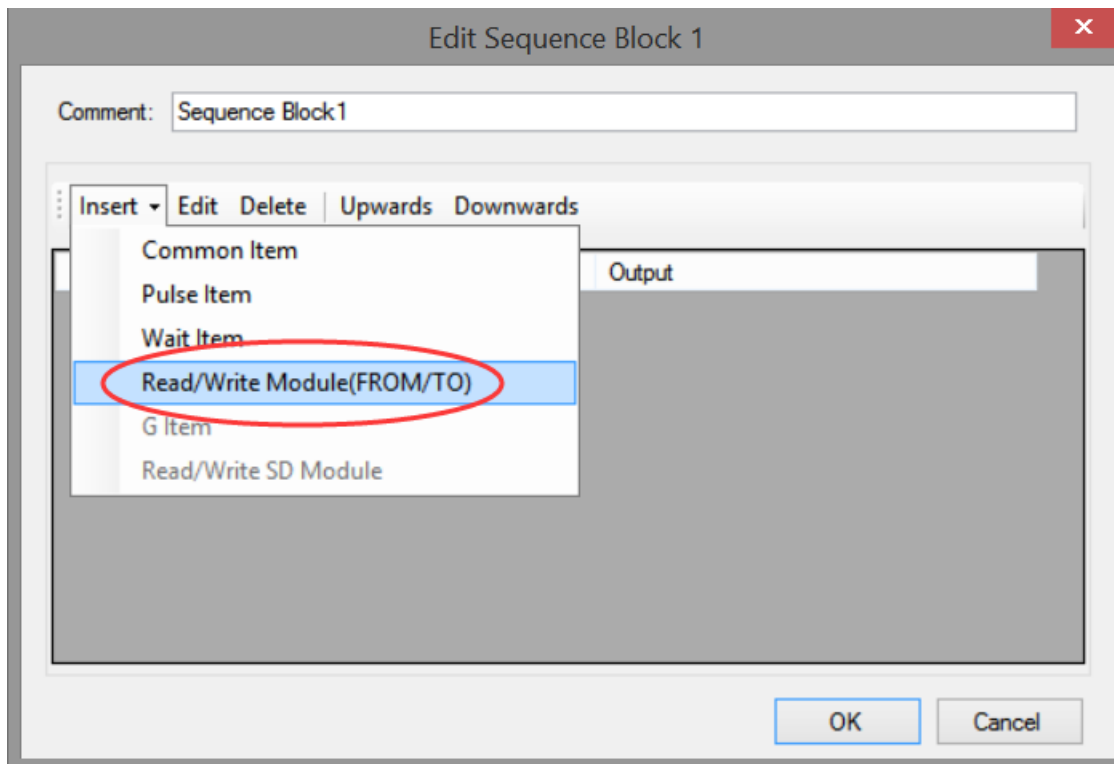

(a) Insert FROM/TO module

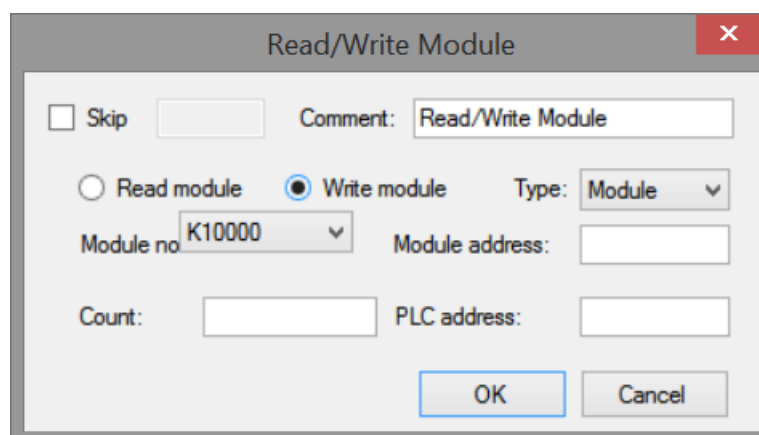

(b) Write instruction

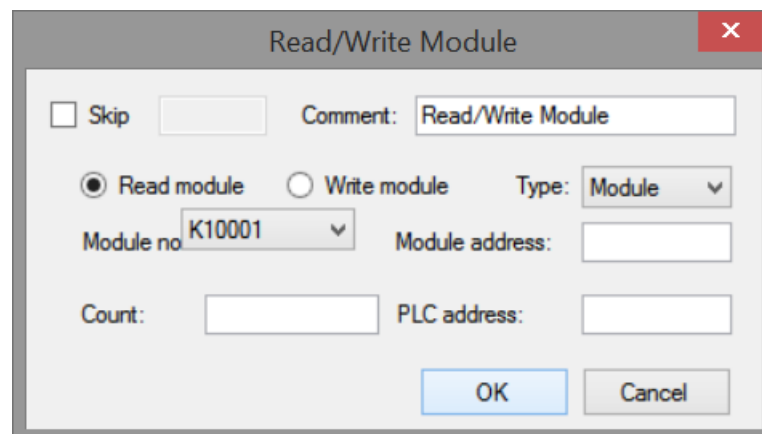

(c) Read instruction

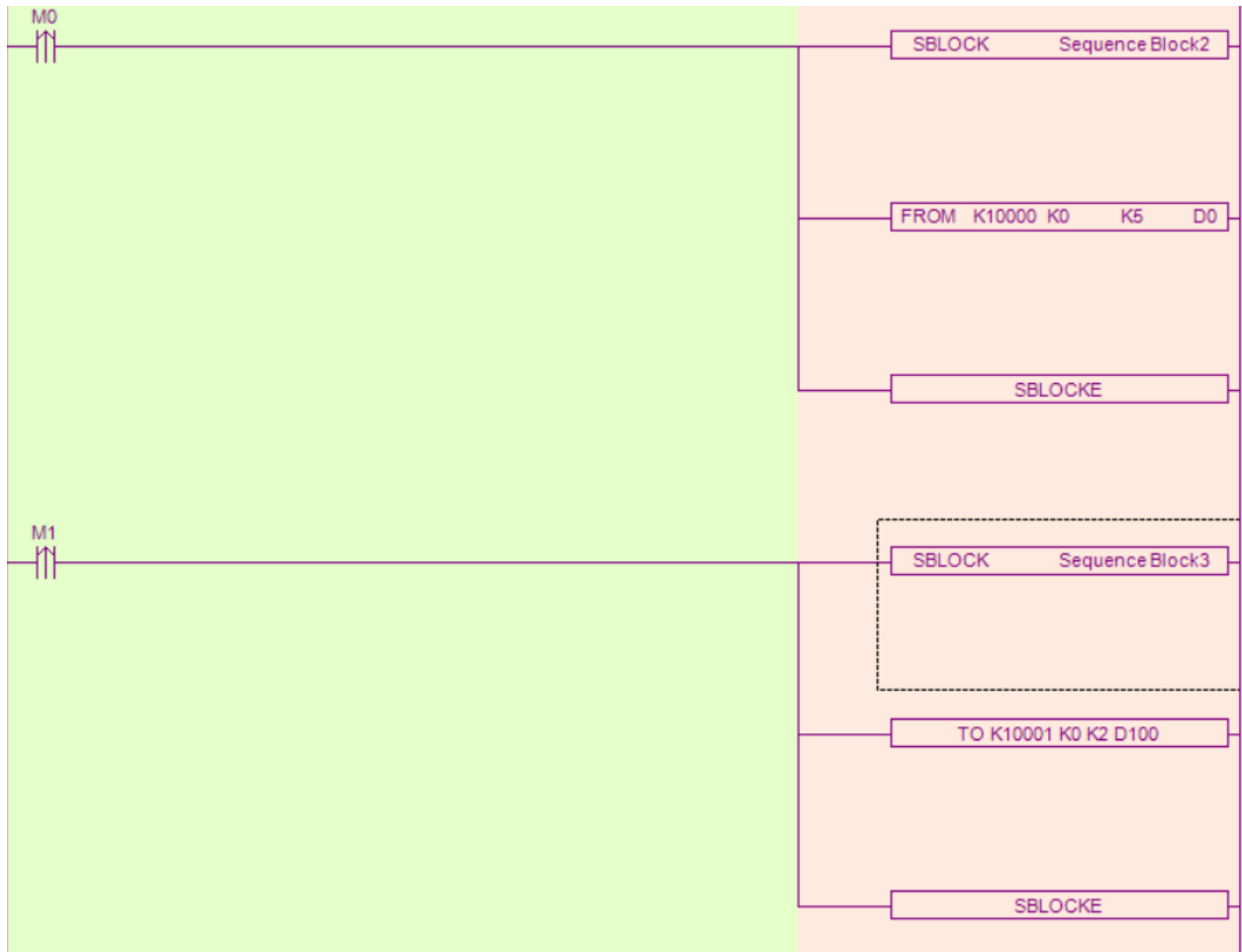

(d) Ladder chart

FROM and TO instructions

(1) Parameter write instruction TO



Function: write the PLC register data to module address, the operate unit is word.

Operand:

S1: target module number, range: 10000~10015. Operand: K, TD, CD, D, HD, FD

S2: first address of module. Operand: K, TD, CD, D, HD, FD

S3: write in register numbers. Operand: K, TD, CD, D, HD, FD

D1: first address of PLC. Operand: TD, CD, D, HD, FD

(2) Parameter read instruction FROM



Function: read the module data to the PLC register, the operate unit is word.

S1: target module number, range: 10000~10015. Operand: K, TD, CD, D, HD, FD

S2: first address of module. Operand: K, TD, CD, D, HD, FD

S3: read register numbers. Operand: K, TD, CD, D, HD, FD

D1: first address of PLC. Operand: TD, CD, D, HD, FD

Note: FROM/TO instructions can only be written in sequential function blocks, and a project can only write 8 sequential function blocks at most.

7-5. Address definition

In the process of using this module, related to parameters and read/write operation objects. The following describes the address arrangement:

Parameter	Address								Read/write
Channel	CH0	CH1	CH2	CH3	CH4	CH5	CH6	CH7	
Auto tune bit	K0	K0	K0	K0	K0	K0	K0	K0	R/W
PID output	K1	K2	K3	K4	K5	K6	K7	K8	R
Target temperature	K9	K10	K11	K12	K13	K14	K15	K16	R/W
Kp	K17	K21	K25	K29	K33	K37	K41	K45	R/W
Ki	K18	K22	K26	K30	K34	K38	K42	K46	R/W
Kd	K19	K23	K27	K31	K35	K39	K43	K47	R/W
Diff	K20	K24	K28	K32	K36	K40	K44	K48	R/W
Temperature control cycle	K49	K50	K51	K52	K53	K54	K55	K56	R/W
Output range	K57	K58	K59	K60	K61	K62	K63	K64	R/W
Temperature offset	K65	K66	K67	K68	K69	K70	K71	K72	R/W
Temperature calibration	K73	K74	K75	K76	K77	K78	K79	K80	W

The module can automatically save the setting temperature value, PID parameters, temperature control cycle, output range, temperature offset and temperature calibration parameters. When writing the above parameters, it is necessary to use the rising edge to trigger the writing, and do not write all the time. It is recommended to write only the parameters that need to be used. It is not recommended to write all the data for the convenience of programming, because writing 0 to some addresses will cause the system to fail to work. Save the parameters when the auto-tuning is finished or modified by the user. Take it out for operation after power on and restart.

7-6. Working mode

There are two ways to set the working mode:

1. XDPpro software
2. Flash registers of PLC

XDPpro software:

Open the XDPpro software, click configure/expansion module settings:

Set the model and channel parameters in the following window. Then click write to PLC.

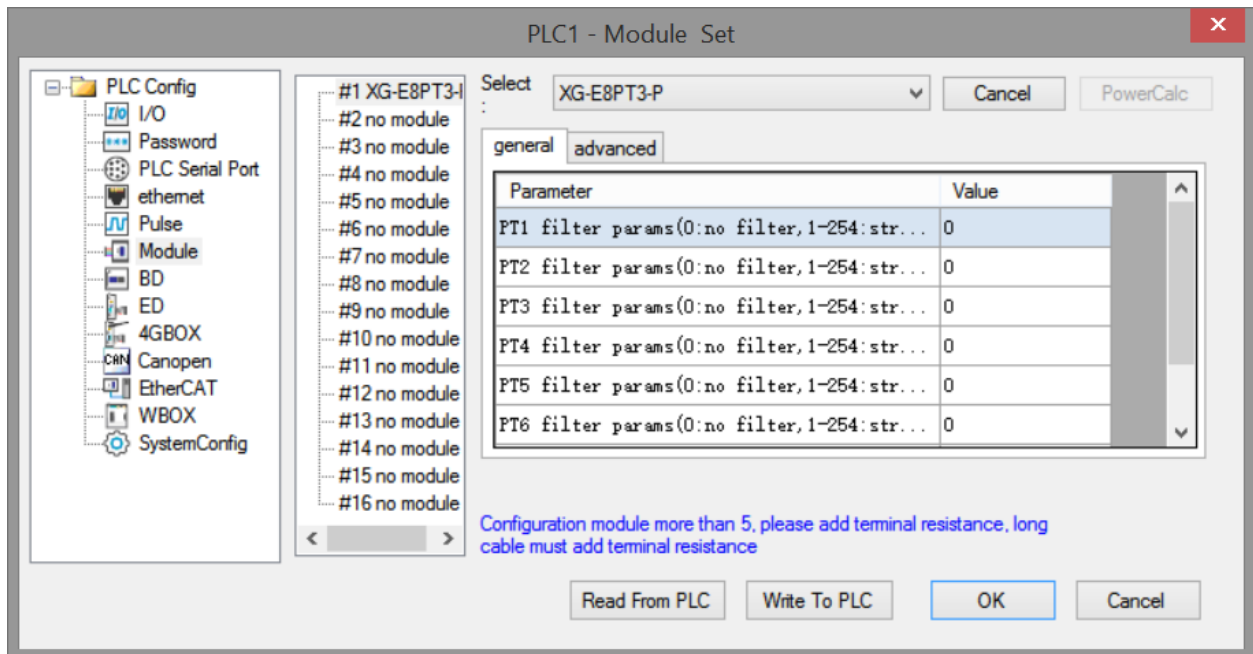

Note: please use software XDPpro v3.5.1 and up.

Flash registers:

Set the filtering parameter through Flash registers of PLC.

Module no.	SFD address	Module no.	SFD address
#1	SFD350~SFD359	#9	SFD430~SFD439
#2	SFD360~SFD369	#10	SFD440~SFD449
#3	SFD370~SFD379	#11	SFD450~SFD459
#4	SFD380~SFD389	#12	SFD460~SFD469

#5	SFD390~SFD399	#13	SFD470~SFD479
#6	SFD400~SFD409	#14	SFD480~SFD489
#7	SFD410~SFD419	#15	SFD490~SFD499
#8	SFD420~SFD429	#16	SFD500~SFD509

Take module 1 as an example:

	Bit7	Bit6	Bit5	Bit4	Bit3	Bit2	Bit1	Bit0	Explanation
Byte0	AD channel 2, 1 filter parameter								AD filter parameter
Byte1	AD channel 4, 3 filter parameter								
Byte2	AD channel 6, 5 filter parameter								
Byte3	AD channel 8, 7 filter parameter								
Byte4~Byte19	-								

Advanced setting:

Click advanced option to set the module upper/lower limit input value alarm, upper/lower limit offset value alarm, alarm dead zone, alarm delay.

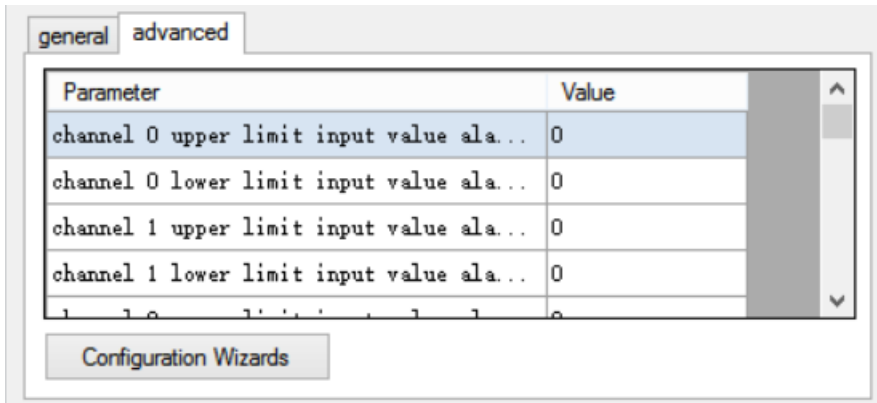

(1) Upper limit input value alarm

When the temperature sampling value is higher than the set value, set the corresponding X1003x, the details are: the upper limit alarm temperature is T_{up} , the dead zone temperature is T_{dead} , the acquisition temperature is $T_{current}$, and the alarm delay value is $Count$. When $T_{current} > T_{up} + T_{dead}$, and the continuous acquisition times are greater than $Count$, the alarm bit is on, and when $T_{current} < T_{up}$, the alarm bit is off.

(2) Lower limit input value alarm

When the temperature sampling value is lower than the set value, set the corresponding X1004x, the details are: the lower limit alarm temperature is T_{down} . When $T_{current} < T_{down}$, and the continuous acquisition times

are greater than Count, the alarm bit is on, and when $T_{current} > T_{down} + T_{dead}$, the alarm bit is off.

(3) Upper limit offset value alarm

Set the difference between the target value and the sampling value to be greater than the set value, set the corresponding X1005x, set it as Terr, and the upper limit offset alarm value is Toffsetup. When $Terr > Toffsetup$, and the cumulative number is greater than Count, the alarm bit is on. When $Terr < Toffsetup$, the alarm bit is off.

(4) Lower limit offset value alarm

Set the difference between the target value and the sampling value to be greater than the set value, set the corresponding X1006x, set it as Terr, and the lower limit offset alarm value is Toffsetdown. When $Terr < Toffsetdown$, and the cumulative number is greater than Count, the alarm bit is on. When $Terr > Toffsetdown$, the alarm bit is off.

7-7. Communication error register assignment

PLC register address		Function description
SD500		Module No. #0~#15 corresponds to #10000~#10015
SD501		Initialization result: 1 is initialization success
SD502	Bit8~Bit15	-
	Bit0~Bit7	Communication error code with PLC
SD503	Bit8~Bit15	Module error type 2: communication timeout 3: Module model mismatch 129: ADC communication error
	Bit0~Bit7	-
SD504		Times
SD505	Bit8~Bit15	Channel 1 error code 0: no error 17: channel short circuit 18: parameter input error
	Bit0~Bit7	Error channel 0~3

7-8. Programming

Example 1: Module 1, PID control for CH0

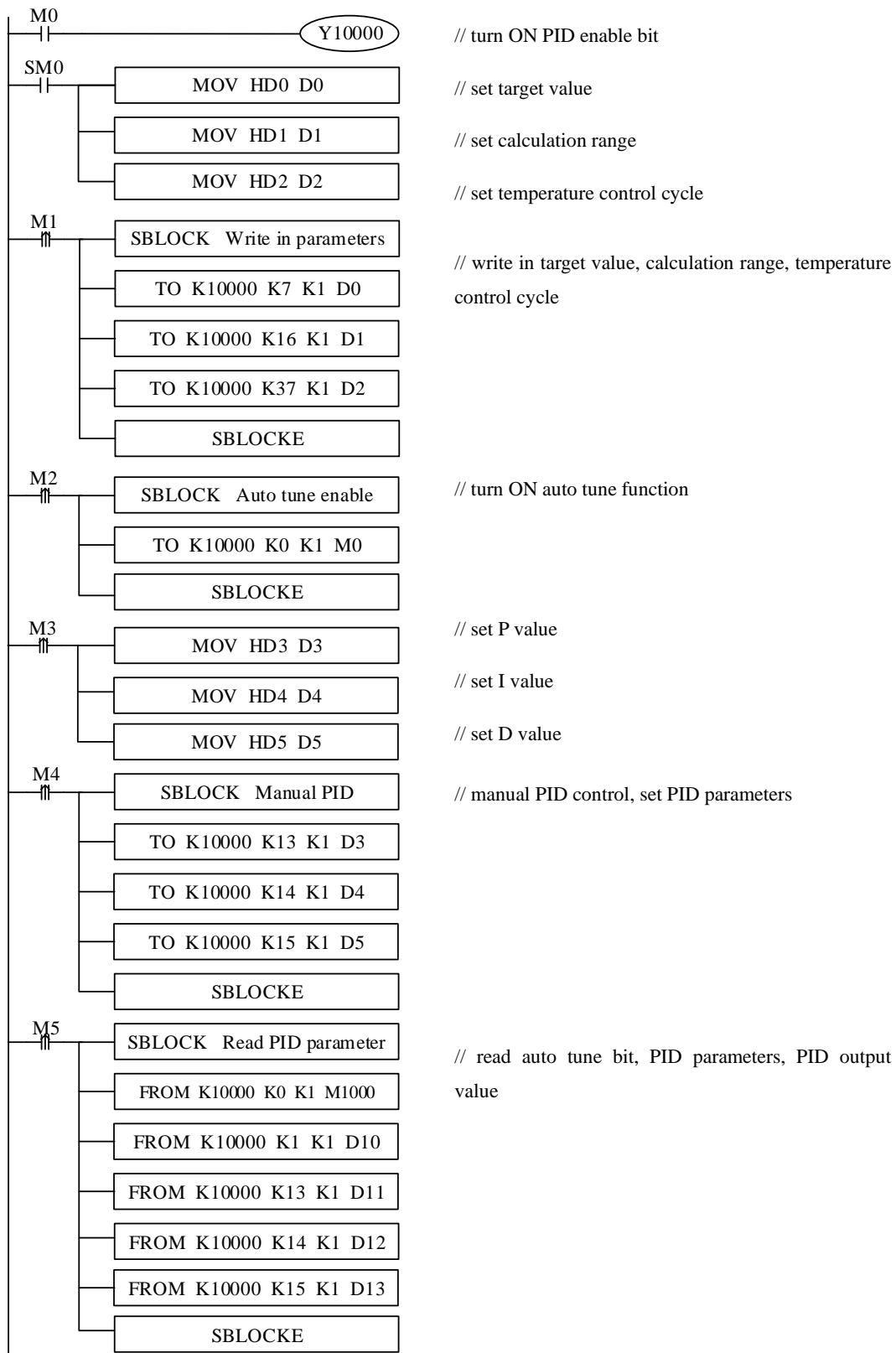

Explanation:

M0: turn ON PID enable

SM0: set target value, calculation range, temperature control cycle

M1: write in target value, calculation range, temperature control cycle

M2: turn ON auto tune function

M3: set manual P, I, D parameters

M4: write in manual P, I, D parameters

M5: read auto tune bit, PID parameters, PID output value

Y10000: channel 0 PID enable bit

HD0: set target value

HD1: calculation range

HD2: temperature control cycle

HD3: P

HD4: I

HD5: D

8. Thermocouple temperature control module XG-E8TC-P

8-1. Specification

XG-E8TC-P temperature PID control module processes the temperature signals of 8-point thermocouples and transmits them to the PLC main unit.

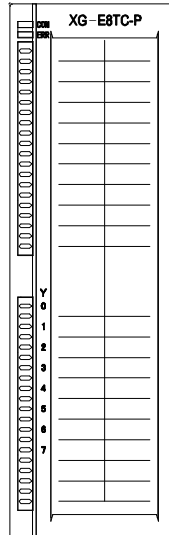

Features:

- Thermocouple sensor K, S, E, N, B, T, J, R signal input
- 8 channels input, 8 channels output, 8 groups of PID parameters, support auto-tune function
- Built-in cold-terminal compensation circuit
- Resolution is 0.1°C
- Up to 16 modules can be connected to the XG series PLC

Specifications:

Item	Contents	
Analog signal input	Thermocouple K, S, E, N, B, T, J, R	
Temperature measurement range	K	0°C~1300°C
	S	0°C~1700°C
	E	0°C~600°C
	N	0°C~1200°C
	B	0°C~1800°C (shows 0 below 250°C)
	T	0°C~400°C
	J	0°C~800°C
	R	0°C~1700°C
Digital output range	0~10000, 16-bit with signed bit, binary	
Control precision	±0.5°C	
Resolution	0.1°C	
Integrate precision	±1% (relative max value)	

Item	Contents
Conversion speed	150ms/ 8 channels
Power supply	DC24V±10%, 50mA
Installation mode	Install on the XG-EB guide rail
Dimension	130.0mm×40.0mm×133.4mm

Note:

1. If no signal input, the channel data is 0.
2. According to the actual requirement to connect the thermocouple.
3. The cover of device which installs thermocouple should be connected to the ground.

8-2. Terminals and wiring

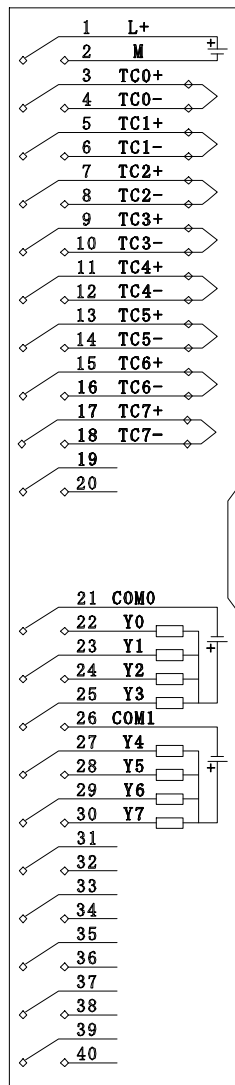

Channel	Terminal	Signal	
CH0	TC0+	0CH thermocouple input +	
	TC0-	0CH thermocouple input -	
CH1	TC1+	1CH thermocouple input +	
	TC1-	1CH thermocouple input -	
CH2	TC2+	2CH thermocouple input +	
	TC2-	2CH thermocouple input -	
CH3	TC3+	3CH thermocouple input +	
	TC3-	3CH thermocouple input -	
Channel	Terminal	Signal	
CH4	TC4+	4CH thermocouple input +	
	TC4-	4CH thermocouple input -	
CH5	TC5+	5CH thermocouple input +	
	TC5-	5CH thermocouple input -	
CH6	TC6+	6CH thermocouple input +	
	TC6-	6CH thermocouple input -	
CH7	TC7+	7CH thermocouple input +	
	TC7-	7CH thermocouple input -	
PID Output	Y0~Y7	0CH~7CH output terminal	Analog output: digital value format, range is 0~4095
			Digital output: Y output during on time in the form of duty cycle
	COM0, COM1	Common terminal of output	
Power supply	L+	+24V power supply	
	M	Common terminal of power supply	

Note:

In order to avoid interference during external connection, please use shielded wire and single point ground the shielded layer.

XG series expansion modules are generally equipped with plug-in spring terminal connectors when they leave the factory. The connector requires that the length of the wire to be stripped is 1.5cm. When wiring, press the yellow spring switch with a small screwdriver, insert the wire into the corresponding jack, and release the spring switch.

Output circuit:

- Output terminal
For transistor output terminals, please use DC5V~30V power supply.
- Circuit insulation
PLC internal circuit and output transistor is optical insulation with optical coupling device. Each public module is separate.
- Response time
The time is less than 0.2ms from PLC driving (or cut) optical coupling circuit to transistor ON/OFF.
- Output circuit

Each point current is 50mA to avoid over-heating.

- Open circuit leak current
Below 0.1mA.

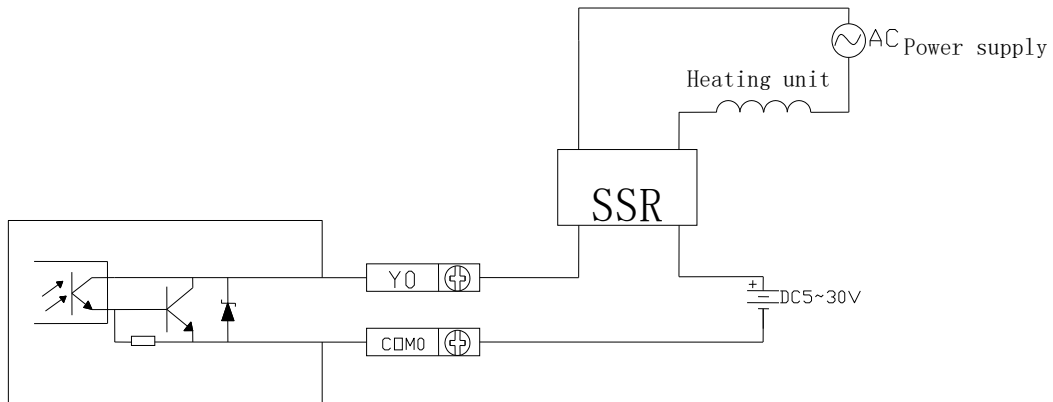

Input characteristic curve of K-type thermocouple

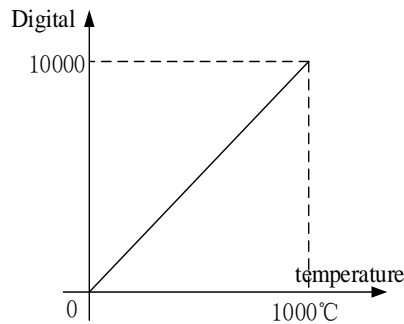

8-3. I/O address assignment

XG series analog module will not occupy I/O unit; the conversion value will be sent to PLC register. Each channel related PLC register address are shown as below:

Parameter	Explanation					
	Channel	CH0	CH1	CH2	...	CH7
Temperature display	Module 1	ID10000	ID10001	ID10002	...	ID10007
	Module 2	ID10100	ID10101	ID10102	...	ID10107
	...	ID10x00	ID10x01	ID10x02	...	ID10x07
	Module 16	ID11500	ID11501	ID11502	...	ID11507
PID enable bit	Module 1	Y10000	Y10001	Y10002	...	Y10007
	Module 2	Y10100	Y10101	Y10102	...	Y10107
	...	Y10x00	Y10x01	Y10x02	...	Y10x07
	Module 16	Y11700	Y11701	Y11702	...	Y11707
PID output (return to PLC X input)	Module 1	X10000	X10001	X10002	...	X10007
	Module 2	X10100	X10101	X10102	...	X10107
	...	X10x00	X10x01	X10x02	...	X10x07

	Module 16	X11700	X11701	X11702	...	X11707
Open circuit detection (0: connected, 1: disconnected)	Module 1	X10010	X10011	X10012	...	X10017
	Module 2	X10110	X10111	X10112	...	X10117
	...	X10x10	X10x11	X10x12	...	X10x17
	Module 16	X11710	X11711	X11712	...	X11717
Auto-tune error (0: normal, 1: auto-tune error)	Module 1	X10020	X10021	X10022	...	X10027
	Module 2	X10120	X10121	X10122	...	X10127
	...	X10x20	X10x21	X10x22	...	X10x27
	Module 16	X11720	X11721	X11722	...	X11727
Temperature upper limit alarm*	Module 1	X10030	X10031	X10032	...	X10037
	Module 2	X10130	X10131	X10132	...	X10137
	...	X10x30	X10x31	X10x32	...	X10x37
	Module 16	X11730	X11731	X11732	...	X11737
Temperature lower limit alarm*	Module 1	X10040	X10041	X10042	...	X10047
	Module 2	X10140	X10141	X10142	...	X10147
	...	X10x40	X10x41	X10x42	...	X10x47
	Module 16	X11740	X11741	X11742	...	X11747
Offset upper limit alarm*	Module 1	X10050	X10051	X10052	...	X10057
	Module 2	X10150	X10151	X10152	...	X10157
	...	X10x50	X10x51	X10x52	...	X10x57
	Module 16	X11750	X11751	X11752	...	X11757
Offset lower limit alarm*	Module 1	X10060	X10061	X10062	...	X10067
	Module 2	X10160	X10161	X10162	...	X10167
	...	X10x60	X10x61	X10x62	...	X10x67
	Module 16	X11760	X11761	X11762	...	X11767
Auto-tune PID control	The auto-tuning trigger signal, enter the auto-tuning stage when it is set to 1. After the auto-tuning is completed, the PID parameter is refreshed and the bit is automatically cleared to zero. The stage can be judged according to its status.					
PID output function (digital value)	Digital value output range is 0~4095					
PID parameters	The optimal parameters can be obtained by PID auto-tuning. You can also set parameters by yourself					
PID calculation range (unit 0.1°C)	This function can set the temperature range of PID calculation. For example, set T_{diff} , target temperature T_{target} , then PID calculation range is $T_{target}-T_{diff} \leq T \leq T_{target} + T_{diff}$, when $T < T_{target}-T_{diff}$, the output is the max, when $T > T_{target} + T_{diff}$, output is 0.					
Temperature offset δ (unit 0.1°C)	Actual temperature = (sampling temperature+temperature offset δ) /10. The value is calculated by the module itself according to the temperature calibration value, and the user does not need to input.					
Setting temperature (unit 0.1°C)	Target temperature of control system. Range is 0~1000°C, precision 0.1°C.					
Temperature control cycle (unit 0.1s)	During PID control, the output terminal will heat according to the duty ratio calculated by the PID output value within the cycle time, which is the temperature control cycle.					

	The adjustment range of the temperature control cycle is 0.5s ~ 200s, the minimum accuracy is 0.1s, and the write value is ten times of the actual temperature control cycle. For example, if 5 is written, the actual temperature control cycle is 0.5s.
Temperature calibration (unit 0.1°C)	If it is considered that there is a deviation between the actual temperature and the module acquisition temperature, the known temperature can be written into the corresponding register. After writing, the module calculates the difference between the collected temperature and the actual temperature according to the value and saves it. Temperature offset δ =actual input temperature -sampling temperature (Note: this value should not be written arbitrarily, otherwise it will cause display temperature error.)
Auto tune output range	The input amount unit of the auto-tuning is % and the input 100 indicates the full-scale output (if no output is found during use, the value can be read to see if it is 0).

Note:

- (1) PID enable bit (Y): when Y is 0, the PID control is turned off, and when Y is 1, the PID control is turned on.
- (2) The module can save the set temperature value, PID parameter value (including P parameter, I parameter, D parameter, DIFF parameter), temperature offset value, temperature control cycle, auto-tuning output amplitude and other parameters. Save when the auto-tuning is finished or modified by the user. Take it out for operation after power on and restart.
- (3) Those marked with * are advanced function settings. Refer to "advanced configuration" in "7-6. Working mode setting" for details of parameters.

FROM and TO instruction explanation:

The reading and writing of thermocouple module needs to be completed through the FROM/TO instruction in the sequential function block, as shown in the figure below:

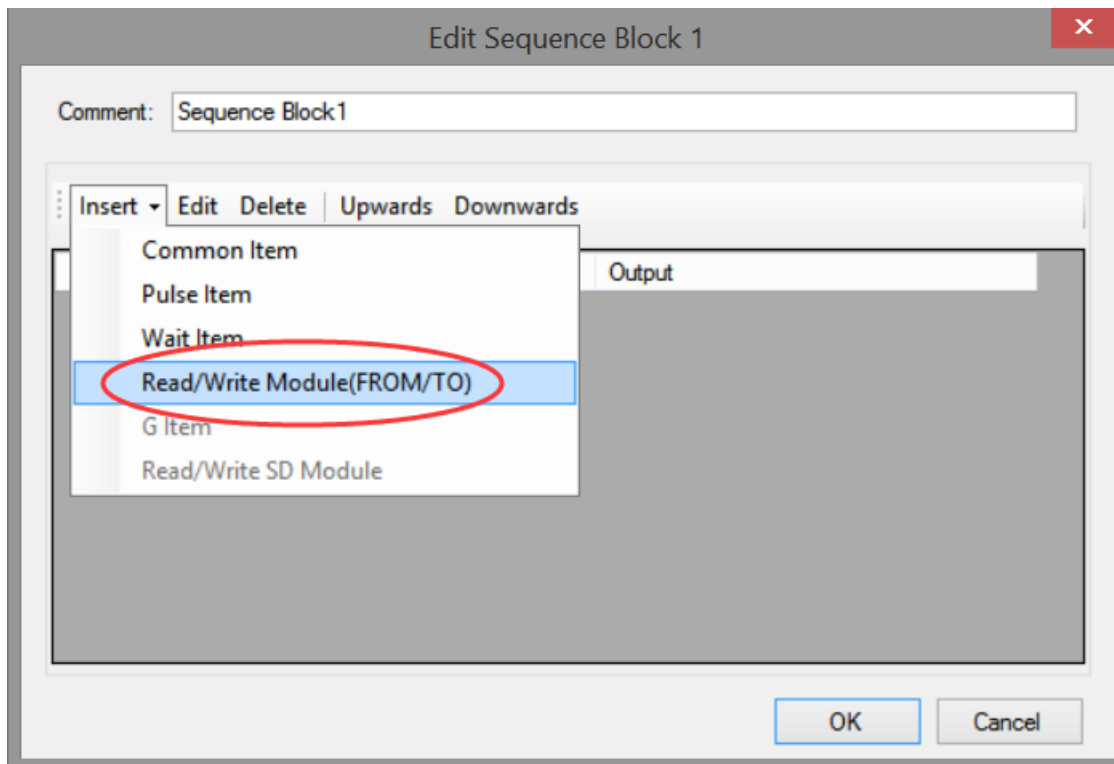

(a) Insert FROM/TO module

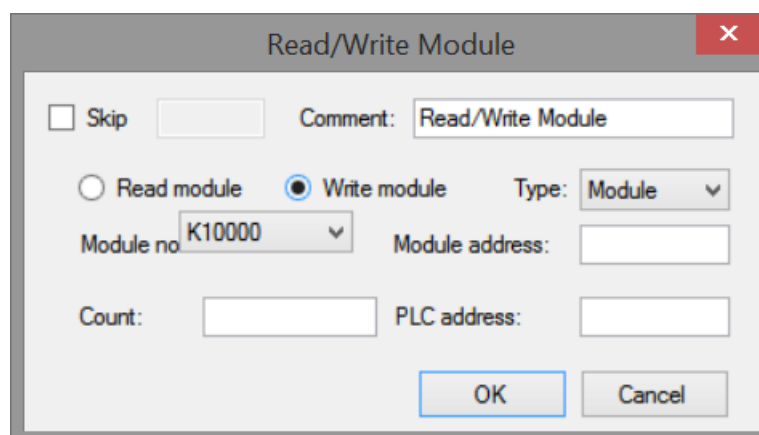

(b) Write instruction

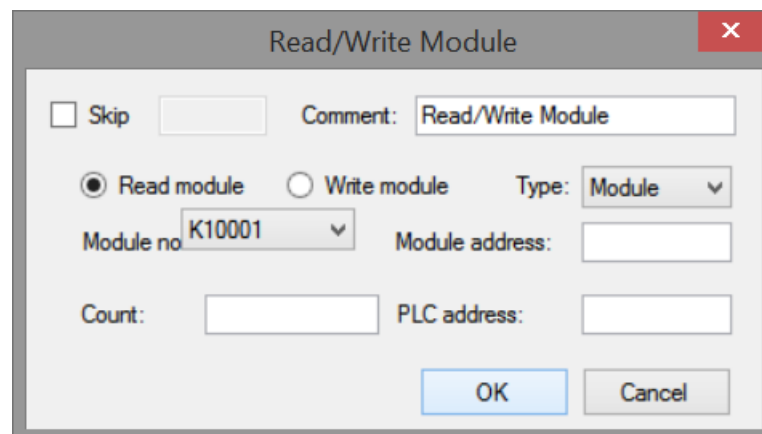

(c) Read instruction

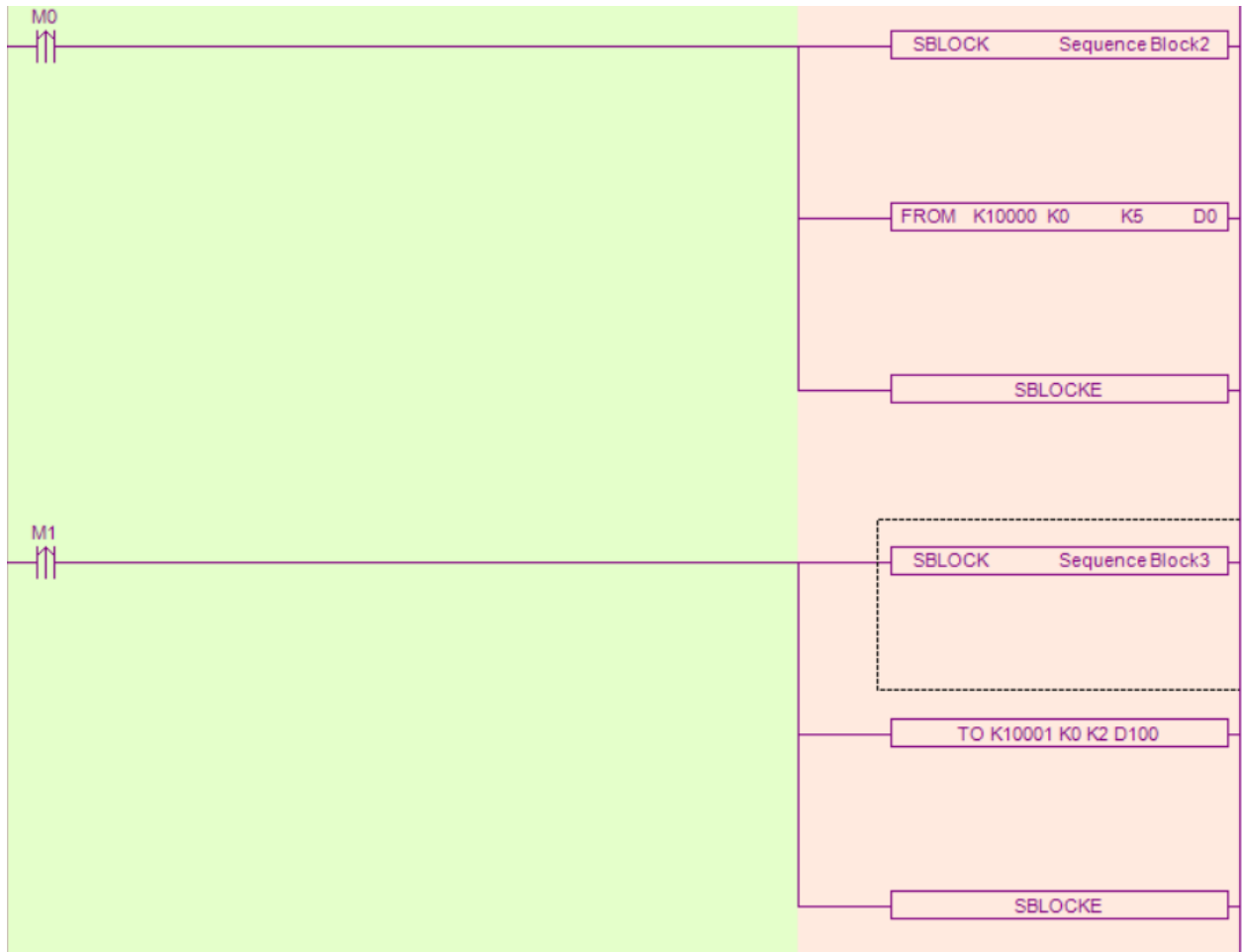

(d) Ladder chart

FROM and TO instructions

Parameter write instruction TO



Function: write the PLC register data to module address, the operate unit is word.

Operand:

S1: target module number, range: 10000~10015. Operand: K, TD, CD, D, HD, FD

S2: first address of module. Operand: K, TD, CD, D, HD, FD

S3: write in register numbers. Operand: K, TD, CD, D, HD, FD

D1: first address of PLC. Operand: TD, CD, D, HD, FD

Parameter read instruction FROM



Function: read the module data to the PLC register, the operate unit is word.

S1: target module number, range: 10000~10015. Operand: K, TD, CD, D, HD, FD

S2: first address of module. Operand: K, TD, CD, D, HD, FD

S3: read register numbers. Operand: K, TD, CD, D, HD, FD

D1: first address of PLC. Operand: TD, CD, D, HD, FD

Note:

1: FROM/TO instruction can only be written in sequence function block, up to 8 function blocks can be written in one program.

Related address definition:

The address of the read/write parameters:

Parameter	Address								Read write
Channel	CH0	CH1	CH2	CH3	CH4	CH5	CH6	CH7	-
Auto tune bit	K0	K0	K0	K0	K0	K0	K0	K0	R/W
PID output	K1	K2	K3	K4	K5	K6	K7	K8	R
Target temperature	K9	K10	K11	K12	K13	K14	K15	K16	R/W
Kp	K17	K21	K25	K29	K33	K37	K41	K45	R/W
Ki	K18	K22	K26	K30	K34	K38	K42	K46	R/W
Kd	K19	K23	K27	K31	K35	K39	K43	K47	R/W
Diff	K20	K24	K28	K32	K36	K40	K44	K48	R/W
Temperature control cycle	K49	K50	K51	K52	K53	K54	K55	K56	R/W
Output range	K57	K58	K59	K60	K61	K62	K63	K64	R/W
Temperature offset	K65	K66	K67	K68	K69	K70	K71	K72	R/W
Temperature calibration	K73	K74	K75	K76	K77	K78	K79	K80	W

Note: the module can automatically save the set temperature value, PID parameters, temperature control cycle, output amplitude, temperature offset and temperature calibration parameters. When the above parameters are written, it is necessary to use the rising edge to trigger the writing. Do not write all the time. It is recommended to write only the parameters used. It is not recommended to write data in the whole chip for the convenience of programming, because writing 0 to some addresses will cause the system to fail to work.

8-4. Working mode

There are two ways to set the working mode:

1. XDPpro software
2. Flash registers of PLC

XDPpro software:

Open the XDPpro software, click configure/expansion module settings:

Set the model and channel parameters in the following window. Then click write to PLC.

Note: please use XDPpro software v3.5.1 and up to configure the module.

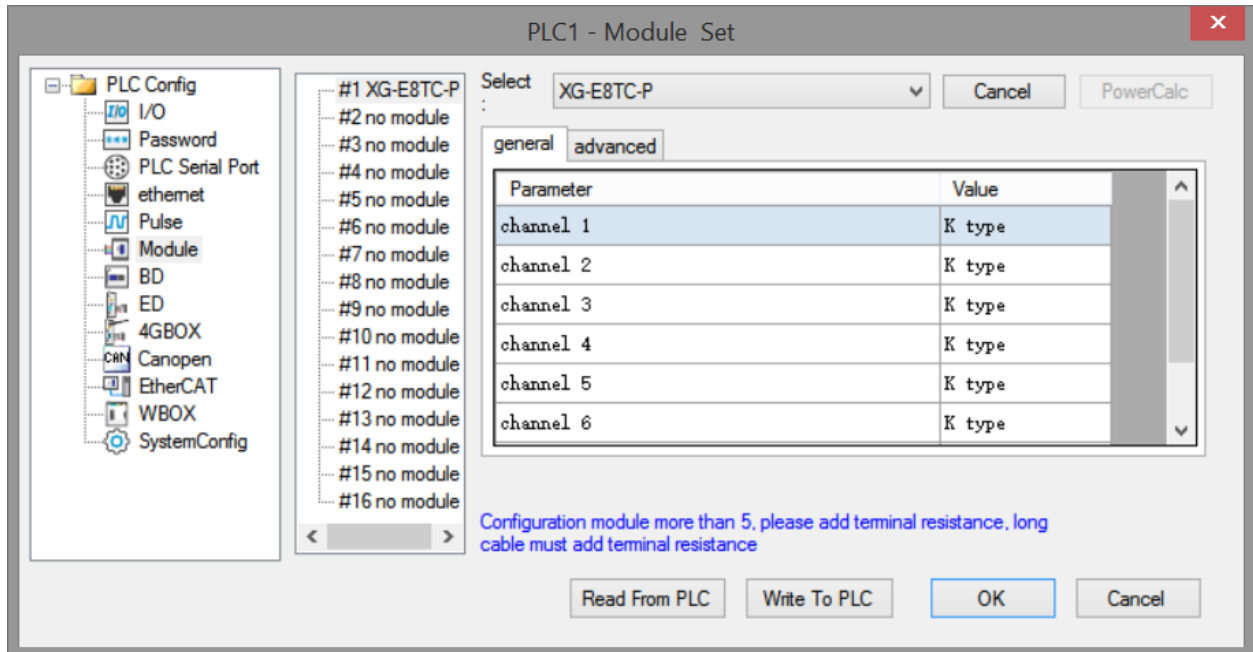

Flash registers:

Set the thermocouple type through SFD registers of PLC:

Module no.	SFD address	Module no.	SFD address
#1	SFD350~SFD359	#9	SFD430~SFD439
#2	SFD360~SFD369	#10	SFD440~SFD449
#3	SFD370~SFD379	#11	SFD450~SFD459
#4	SFD380~SFD389	#12	SFD460~SFD469
#5	SFD390~SFD399	#13	SFD470~SFD479

#6	SFD400~SFD409	#14	SFD480~SFD489
#7	SFD410~SFD419	#15	SFD490~SFD499
#8	SFD420~SFD429	#16	SFD500~SFD509

SFD bit definition:

Expansion module no.1 setting:

	Bit7	Bit6	Bit5	Bit4	Bit3	Bit2	Bit1	Bit0	Explanation
Byte0	AD channel 2, channel 1 graduation								AD graduation
Byte1	AD channel 4, channel 3 graduation								
Byte2	AD channel 6, channel 5 graduation								
Byte3	AD channel 8, channel 7 graduation								
Byte4~Byte19	-								

8-5. Communication error register assignment

PLC register address		Function description
SD500		Module No. #0~#15 corresponds to #10000~#10015
SD501		Initialization result: 1 is initialization success
SD502	Bit8~Bit15	-
	Bit0~Bit7	Communication error code with PLC
SD503	Bit8~Bit15	Module error type 2: communication timeout 3: Module model mismatch 129: ADC communication error
	Bit0~Bit7	-
SD504		Times
SD505	Bit8~Bit15	Channel 1 error code 0: no error 17: channel short circuit 18: parameter input error
	Bit0~Bit7	Error channel 0~3

8-6. Programming

Example 1: Module 1, PID control for CH0

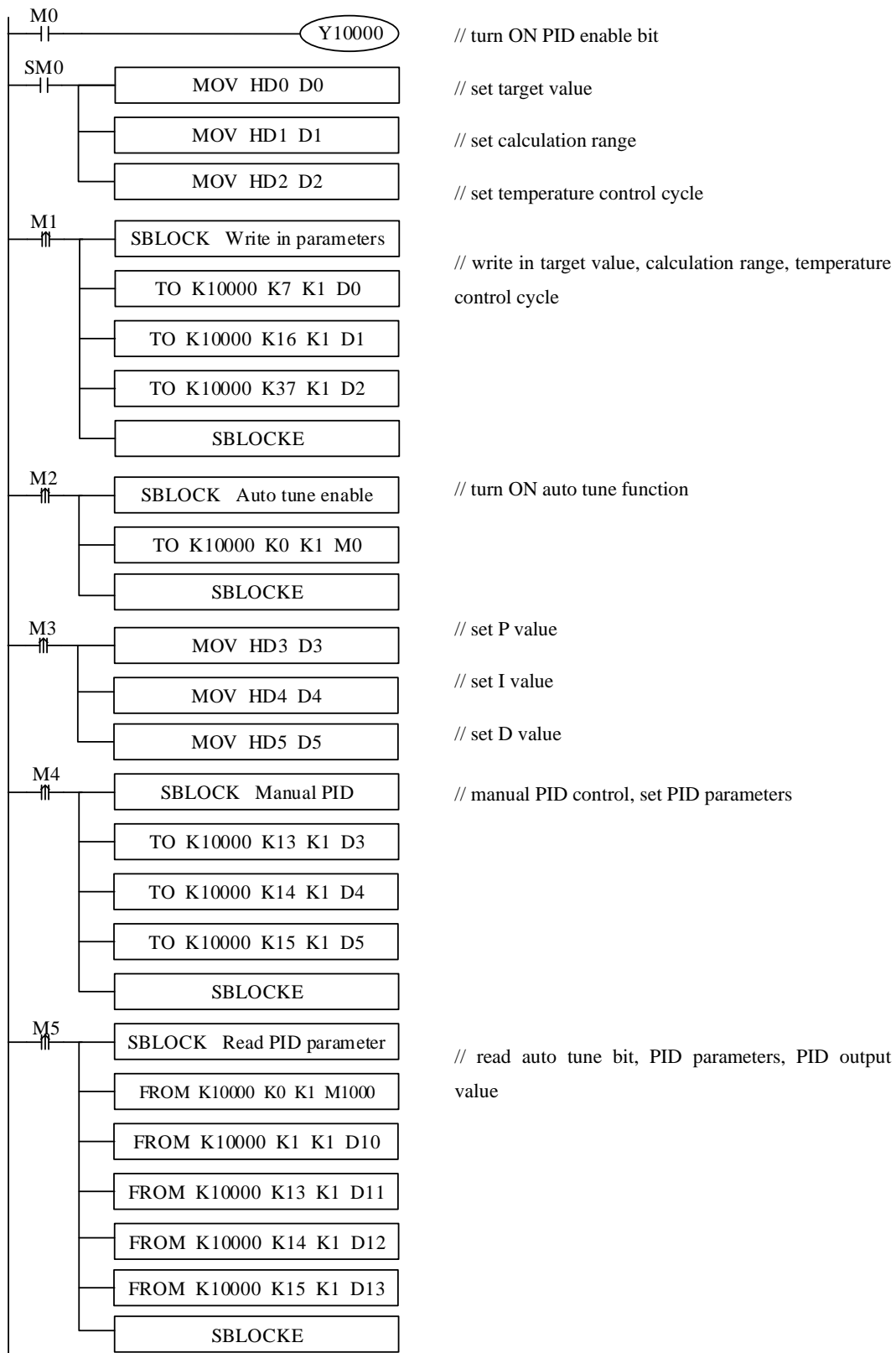

Explanation:

M0: turn ON PID enable

SM0: set target value, calculation range, temperature control cycle

M1: write in target value, calculation range, temperature control cycle

M2: turn ON auto tune function

M3: set manual P, I, D parameters

M4: write in manual P, I, D parameters

M5: read auto tune bit, PID parameters, PID output value

Y10000: channel 0 PID enable bit

HD0: set target value

HD1: calculation range

HD2: temperature control cycle

HD3: P

HD4: I

HD5: D

XINJE



WUXI XINJE ELECTRIC CO., LTD.

No.816, Jianzhu West Road, Binhu District,
Wuxi City, Jiangsu Province, China

Tel: 86-0510-85134139

Fax: 86-0510-85111290

www.xinje.com